

~~OFFICIAL USE ONLY~~
MANHATTAN DISTRICT HISTORY

BOOK III
THE P-9 PROJECT

~~OFFICIAL USE ONLY~~

3A

271
THIS DOCUMENT CONTAINS OF 267 PAGES
NO. 3 OF 4 SERIES A

~~SECRET~~

2582

4401

MANHATTAN DISTRICT HISTORY

BOOK III

THE P-9 PROJECT

~~SECRET USE ONLY~~

CLASSIFICATION CANCELED
DOE NSI DECLASSIFICATION REVIEW E.O. 12958
BY: E.A. Holzer g/h DOE/SO-70 10/21/05

~~SECRET~~

~~SECRET~~
8 April 1947

~~SECRET~~
FOREWORD

This book, comprised of a summary, a main history in six sections, and four appendices, is intended to present a brief but reasonably complete account of the whole F-9 Project.

The records of the Office of Major General L. K. Groves, Washington, D. C., and of the Manhattan District, Oak Ridge, have formed the principal sources of the data on which this report is based. These have been supplemented by consultations, discussions and correspondence with those concerned in the administration, research, development, construction and operation of the project; also by inspection of the installations. All statements and all figures, insofar as possible, have been checked at their original sources.

The period covered by this Book extends from the inception of the F-9 project to the termination of Manhattan District control on 31 December 1946.

The summary, as its name implies, is a condensation of the main history. Its headings, sections, paragraphs and subparagraphs are designated by numbers and letters identical with those of the corresponding portions of the main history; therefore, any reader of the summary who desires more detailed information on any paragraph may readily turn to the corresponding paragraph (or group of paragraphs) in the main history. All references to source data are confined to the main history, wherein they are usually

~~SECRET~~
~~CONFIDENTIAL USE ONLY~~



inserted parenthetically; each reference directs the reader to the appropriate appendix, where the drawing, photograph, or document itself, or else its title, location and file designation, may be found. To avoid repetition, references to the appendix listings of the Technical Reports and the Contracts have been generally omitted; these documents are separately listed in Appendices C1 and C2 and they can be readily identified from their designations in the text.

TABLE OF CONTENTS

<u>Par. No.</u>		<u>Page No.</u>
	<u>FOREWORD</u>	F1, F2
	<u>SUMMARY</u>	S1 - S21
	<u>SECTION 1. GENERAL</u>	
1-1.	Purpose	1.1
1-2.	Authorization	1.3
	<u>SECTION 2. RESEARCH AND DEVELOPMENT</u>	
2-1.	Basic Theory	2.1
2-2.	Specific Research Projects	2.2
2-3.	General Investigations	2.5
2-4.	Decisions Required	2.6
2-5.	Processes Considered	2.6
2-6.	Principal Decisions	2.8
	a. Decision for Trail Plant	2.8
	b. Decisions for Plants in U. S.	2.10
2-7.	Specifications of the Product	2.13
	<u>SECTION 3. DESIGN AND ENGINEERING</u>	
3-1.	Plant at Trail, B. C.	3.1
	a. Site	3.1
	(1) Description	3.1
	(2) Lease Arrangements	3.2
	b. Contracts	3.3
	c. Procedure	3.4
	d. Description of Process	3.5
	(1) Primary Plant	3.5
	(2) Secondary Plant	3.7
	(3) Catalysts	3.7
	(a) Platinum-Charcoal	3.8
	(b) Nickel-Chromium	3.9
	e. Costs	3.11
3-2.	Plants in the United States.	3.11
	a. Sites	3.11
	(1) Morgantown Ordnance Works	3.11
	(2) Wabash River Ordnance Works	3.13
	(3) Alabama Ordnance Works	3.15

Par. No.

Page No.

<u>b.</u>	Contracts	3.16
<u>c.</u>	Procedure	3.17
<u>d.</u>	Description of Process	3.18
	(1) Water Distillation	3.18
	(2) Electrolytic Finishing	3.20
<u>e.</u>	Costs	3.21

SECTION 4. CONSTRUCTION

4-1.	Plant at Trail, B. C.	4.1
<u>a.</u>	Contracts, Orders and Leases	4.1
	(1) Prime Construction Contract	4.1
	(2) Architect-Engineer-Manager Contract	4.1
	(3) Supply Contracts	4.1
	(4) Purchase Orders	4.2
	(5) Lease Arrangements	4.2
<u>b.</u>	Description	4.2
	(1) Site Plan	4.2
	(2) Buildings	4.3
	(3) Utilities	4.6
	(4) Fence	4.7
<u>c.</u>	Progress	4.7
<u>d.</u>	Costs	4.9
4-2.	Plant at Morgantown Ordnance Works.	4.10
<u>a.</u>	Contracts	4.10
	(1) Prime Contract	4.10
	(2) Subcontracts	4.10
<u>b.</u>	Description	4.10
	(1) Site Plan	4.10
	(2) Buildings	4.10
	(3) Additional Facilities	4.12
	(4) Utilities	4.13
<u>c.</u>	Progress	4.13
<u>d.</u>	Costs	4.15
4-3.	Plant at Wabash River Ordnance Works.	4.16
<u>a.</u>	Contracts	4.16
	(1) Prime Contract	4.16
	(2) Subcontracts	4.16
<u>b.</u>	Description	4.16
	(1) Site Plan	4.16
	(2) Buildings	4.16
	(3) Utilities	4.19
<u>c.</u>	Progress	4.19
<u>d.</u>	Costs	4.20
4-4.	Alabama Ordnance Works.	4.21
<u>a.</u>	Contracts	4.21
	(1) Prime Contract	4.21
	(2) Subcontracts	4.21

~~SECRET~~

<u>Par. No.</u>	<u>Page No.</u>
b. Description	4.21
(1) Site Plan	4.21
(2) Buildings	4.22
(3) Additional Facilities	4.23
(4) Utilities	4.23
c. Progress	4.24
d. Costs	4.25
4-5. Recapitulation of Costs	4.26

SECTION 5. OPERATION

5-1. Plant at Trail, B. C.	5.1
a. Contracts	5.1
b. History of Operation	5.4
(1) Start-up	5.4
(2) Production	5.6
c. Production Records	5.8
d. Production Costs	5.9
(1) Operating Costs	5.9
(2) Total Cost per Pound of Product	5.11
5-2. Plants in the United States	5.11
a. Contracts	5.11
(1) Morgantown Ordnance Works	5.11
(2) Wabash River Ordnance Works	5.12
(3) Alabama Ordnance Works	5.12
(4) General	5.12
b. Procedure	5.13
c. History of Operation	5.14
(1) Start-up	5.14
(a) Morgantown Ordnance Works	5.14
(b) Wabash River Ordnance Works	5.14
(c) Alabama Ordnance Works	5.14
(2) Production	5.15
d. Production Records	5.25
e. Production Costs	5.25
(1) Operating Costs and Operating Fees	5.25
(2) Total Cost per Pound of Product	5.28
5-3. Recapitulation	5.29
a. Production Records	5.29
b. Production Costs	5.30
c. Total Cost per Pound of Product	5.30
5-4. Shipments of Material	5.31

SECTION 6. ORGANIZATION AND PERSONNEL

6-1. Administration	6.1
6-2. Research and Development Personnel	6.2

~~SECRET~~

~~SECRET~~

<u>Par. No.</u>	<u>Page No.</u>
6-3. Design Personnel	6.3
6-4. Construction Personnel	6.3
6-5. Operating Personnel	6.4
6-6. General	6.5

APPENDICES

- A. Drawings
- B. Photographs
- C. Lists of Special Documents (in Files)
(Technical Reports and Contracts)
- D. List of Other Data in Files.

INDEX

II - 14

~~SECRET~~

~~SECRET~~

SUMMARY

1. General.

1-1. The Purpose of the so-called P-9 Project was to provide "heavy water", or deuterium oxide, for the manufacture of plutonium and for other war uses which might develop. The purpose of the project has been successfully attained: heavy water has been produced in the required quantities.

1-2. Authorization. All action in connection with this project was taken under authority granted by Congress and in accordance with orders issued by the President in conformity therewith, as generally set forth in another book. Major General L. R. Groves directed or authorized the general policies and directives under which the Manhattan District carried out the work. The S-1 Committee of OSRD and the Military Policy Committee registered their general approval of the basic decisions involved.

2. Research and Development.

2-1. Basic Theory. Science had previously determined that natural water is composed of "light" water and deuterium oxide or "heavy" water, and that natural hydrogen likewise has two components, which are isotopes, "light" hydrogen and "heavy" hydrogen. The problem presented for solution was the production of heavy water -- from natural water, or from heavy hydrogen first produced from natural hydrogen, or by some other practicable means.

2-2. Specific Research Projects. Both before and after the project was turned over to the War Department, as represented

~~SECRET~~

~~SECRET~~

by the Manhattan District, in the summer of 1942, the OSRD entered into a number of contracts, on behalf of the Government, for research and development work on this problem. This work was carried out principally by Standard Oil Development Co., Columbia University, Northwestern University, University of Minnesota, Universal Oil Products Company, Consolidated Mining & Smelting Co., of Canada, Ltd., of Trail, B. C., Canada, and E. I. du Pont de Nemours and Company. The work under most of these contracts, and the preparation of the technical reports which they called for, continued after the project was transferred to the Manhattan District.

2-3. General Investigations indicated that the plant of the Consolidated Mining & Smelting Co., at Trail, B. C., was the only existing hydrogen producing plant in either the United States or Canada in which hydrogen was manufactured by the electrolytic method in the quantities required. The early investigations also indicated that hydrogen obtained by the electrolytic method might be the most suitable for producing heavy water. These facts automatically determined the location, subsequently, of one of the heavy water producing plants and precluded the use of the same process elsewhere.

2-4. The major Decisions Required included: what process or processes should be fully developed and used; to what production capacities selected processes should be developed; and where the manufacturing plants should be located. The decisions finally reached

~~SECRET~~

were unanimously approved in all important respects by those in charge and their consultants. H²

2-5. The Processes Considered were many. The choice was finally narrowed down to the following four: (1) the "hydrogen-water exchange" process, in combination with the "electrolytic" process, (2) the "water distillation" process, (3) the "hydrogen sulphide-water duotemperature exchange" process, and (4) the "triethylamine" process.

2-6. The Principal Decisions based on the research and development work and the first steps taken to carry them out were:

a. Decision for Trail Plant: To install facilities at the existing ammonia plant of the C M & S Co. in Trail, B. C. for production of heavy water at an estimated rate of about 0.5 tons per month, by the "hydrogen exchange" process, using natural water from the Columbia River and the hydrogen already in production at that plant. To implement this decision contracts were made, on behalf of the Government, with the CM&S Co. (for development, design and construction), with E. B. Badger & Sons Company (for engineering and design of an "exchange unit") and with Stone and Webster Engineering Corporation (for engineering, construction and managerial services.)

b. Decisions for Plants in United States: To install supplementary facilities at three existing U. S. Government Ordnance Works, namely, Morgantown Ordnance Works, Wabash River Ordnance Works, and Alabama Ordnance Works, for production of heavy water at estimated rates of 0.4 tons, 1.2 tons, and 0.6 tons per month, respectively, by the "water distillation" process, using steam to be obtained insofar as possible from excess supplies

~~SECRET~~

available at the plants, and using natural water from local sources. To implement these decisions a contract was made with the du Pont Company providing for design of the required facilities, later superseded by supplements to existing separate Ordnance Department contracts for the respective plants.

2-7. The Specifications of the Product, as devised with the assistance of the Metallurgical Laboratory of the University of Chicago, provided principally that the minimum concentration of heavy water for any shipment of finished product should be 99.7% and the minimum average concentration of heavy water for all shipments should be 99.75%.

3. Design and Engineering.

3-1. Plant at Trail, B. C.

a. The Site of the Trail plant is located on the property of the C M & S Co., mostly at the works of that company's Chemical and Fertilizer Division at Warfield, B. C., about 2 miles west of Trail. The principal advantages of this site were: the existing plant facilities, including particularly the hydrogen gas which was available; and the benefit of the experience of the personnel at the plant, in connection with design, construction and operation. The only disadvantage was location outside the United States, and the advantages far outweighed this disadvantage.

Lease arrangements were made for the United States Government to lease six parcels of land from the C M & S Co. and a seventh parcel from the Allied War Supplies Corporation,

~~SECRET~~

~~SECRET~~

representing the Canadian Government. These parcels, upon which the new construction was placed, totalled 0.474 acres.

b. Contracts for design and engineering for this plant were made with Stone and Webster Engineering Corporation and Consolidated Mining & Smelting Co.; subcontracts were made by Stone & Webster with E. B. Badger & Sons Co. and Universal Oil Products Company.

c. The Procedure followed required in general that all design and engineering work first performed by C M & S Co. and Badger, should be checked and reviewed by Stone and Webster and approved by representatives of the OSRD S-1 Committee and the Manhattan District.

d. The Description of Process may be summarized with extreme brevity as follows:

(1) In the Primary Plant, normal water is led downward through three first stage towers wherein it meets up-flowing hydrogen in the presence of a catalyst and thereby increases its concentration of heavy water, some of the light hydrogen component of the natural water being displaced by the heavy hydrogen component of the upflowing hydrogen. Essentially the same procedure is repeated in the second, third and fourth stage towers.

(2) In the Secondary Plant, the water drawn from the fourth stage of the primary plant (containing approximately 2.3% heavy water) passes successively through three stages or batteries of electrolyzing cells; in the cells of each stage it is

~~SECRET~~

broken down electrically into hydrogen and oxygen; the liquid remaining in the cells becomes increasingly concentrated with heavy water, and the finally concentrated product, approximately 99.8% heavy water, is drawn from the third stage cells.

(3) Two Catalysts were developed for use in the process; (a) Platinum-charcoal and (b) Nickel-chromium. The latter was planned and ordered as a reserve, but its production was discontinued when the platinum-charcoal catalyst, manufactured by J. T. Baker & Co., had proved to be satisfactorily efficient and durable.

e. Costs of design and engineering are included with costs of construction, etc., set forth hereinafter, as they have not been segregated.

3-2. Plants in the United States.

a. The Sites in the United States which were selected for the location of the three plants for the manufacture of heavy water by the water distillation process were Government-owned reservations at which Ordnance Works were in existence and still under construction:

(1) Morgantown Ordnance Works, Morgantown, Monongalia County, West Virginia.

(2) Wabash River Ordnance Works, Newport, Vermillion County, Indiana.

(3) Alabama Ordnance Works, Sylacauga, Talladega County, Alabama.

The principal advantages of these sites were: the existing ^{available} plant facilities of the various Ordnance Works, including steam generating facilities and other utilities; the availability of various services and personnel; and land already owned by the Government. These factors effected savings in time and in costs of construction and operation which would not have been possible at any other sites.

b. Contracts for design and engineering for these plants were made with E. I. du Pont de Nemours & Co., in the form of supplements to existing War Department cost-plus-a-fixed-fee Ordnance contracts.

c. The Procedure followed provided, in substance, for general supervision of design by the Manhattan District and general administrative control by the Ordnance Department, which has cooperated efficiently with the District throughout the work. Sound considerations of administrative control influenced the decision to locate the electrolytic finishing plant (for increasing the concentration of the semi-finished material withdrawn from the three distillation plants) at the Morgantown Ordnance Works rather than at one of the other Ordnance Works.

d. The Description of Process may be summarized with extreme brevity as follows:

(1) The Water Distillation process is carried out in eight stages, each of which has its own distillation tower or towers. Normal water is led downward through a series

of plates within the first stage towers, meeting upflowing steam or vapor arising from water boiling in the bottom portions of the towers, and picking up heavy water therefrom. The water collected in the bottoms of these towers, now more concentrated with heavy water, is fed to the tops of the second stage towers and essentially the same procedure is repeated in each succeeding stage through the eighth.

(2) In the Electrolytic Finishing Plant (at Morgantown Ordnance Works only) the feed water, about 90% heavy water, coming from the eighth stage of each water distillation plant, is fed in batches to electrolyzing cells; in this process the semi-finished feed water is broken down into hydrogen and oxygen; and the heavy water therein tends to remain in the cells while the light water is driven off. The process is repeated through several stages, producing the finally concentrated product, 99.7% or more heavy water.

e. Costs of engineering and design for the water distillation plants are included with the costs of construction and equipment hereinafter, as they have not been segregated.

4. Construction.

4-1. Plant at Trail.

a. Contracts, Orders and Leases. The prime construction contract was a cost-plus-a-fixed-fee contract negotiated by the War Department with Consolidated Mining and Smelting Company of Canada, Ltd. Supply contracts for catalysts were made with Harshaw Chemical Company and J. T. Baker & Company. Purchase

~~SECRET~~

Orders for fractionating towers were issued to S. K. Hicks Engineering Company, Inc., and Artisan Metal Products Company, Inc.; also, for catalyst, to Baker & Company. Leases for land have been described previously.

b. Description. The new buildings constructed included the Booster and the Primary Evaporator Buildings, the Primary Tower Structure, Cooling Tower, Pump House, Oxygen Scrubber Tower, and Catalyst Shed; additions to existing buildings included the Secondary Concentration Plant, the Assay Laboratory and the Steam Boiler Plant. All the principal structures conform in general architectural treatment and construction to the existing buildings nearby, with brick exterior walls, built-up roofing and concrete foundations; the others are mainly of temporary construction, with corrugated transite siding. These buildings house all the equipment required essentially for the production of the heavy water.

For the most part the existing utilities, with necessary extensions and connections, serve the new plant.

c. Progress. Construction started 1 September 1942 and was completed 30 June 1943, with no material delays. The Secondary Concentration Cell Plant was transferred to the operators 1 May and the first stage towers 16 June 1943.

d. Costs. including all War Department costs for design and engineering as well as construction and equipment and including OSRD Expenditures from War Department funds, totalled, as of 31 December 1946, \$2,604,522. The contractor's fixed fee was one dollar.

~~SECRET~~

4-2. Plant at Morgantown Ordnance Works.

a. Contracts. The prime construction contract was the same cost-plus-a-fixed-fee supplement to the Ordnance Contract with the du Pont Company which covered design and engineering. Subcontracts were let for special parts of the work.

b. Description. The new buildings constructed included the Process Pump and Control Building (with the Distillation Towers and other equipment); the Finishing (Electrolytic) Building; the Change House, Office and Laboratory Building; the Product Storage Building; Cooling Tower; and Low Pressure Boiler House. These buildings are mainly of temporary construction, with wood frame, corrugated asbestos siding, built-up roof and concrete foundations, except the Boiler House, which has a structural steel frame. They house the equipment required essentially for the production of the heavy water. Some other equipment was also installed in the existing Power House and the existing Filter Plant. For the most part the existing utilities, with necessary extensions and connections, serve the new plant.

c. Progress. Construction started 7 January 1943 and was completed (except for changes during operation) 31 December 1943, with no material delays. The first unit of the plant was placed in initial operation 29 May 1943 and the last 28 August 1943.

d. Costs, including engineering and design as well as construction and equipment, but not including any costs incurred

~~SECRET~~

under OSRD contracts, totalled, as of 31 December 1946, \$5,475,205. The contractor's fixed fee was \$88,588, included in the total.

4-3. Plant at Wabash River Ordnance Works.

a. Contracts. The prime construction contract was the same cost-plus-a-fixed fee supplement to the Ordnance Contract with the du Pont Company which covered design and engineering. Sub-contracts were let for special parts of the work.

b. Description. Except for the omission of the electrolytic finishing building and except for differences in sizes of buildings, the new plant buildings here were similar to those at Morgantown. An Area Gate and Guard House and a warehouse or shop were also constructed, and instead of the low-pressure boiler house (at Morgantown), an addition was built to the existing Power House. For the most part the existing utilities, with necessary extensions and connections, serve the new plant, but the existing water supply system was supplemented by new wells.

c. Progress. Construction started 23 January 1943 and was completed 13 December 1945, with no material delays. Initial operation of the units began 17 June 1945 and all stages were ready for full operation 18 September 1945.

d. Costs, including engineering and design as well as construction and equipment, but not including any costs incurred under OSRD contracts, totalled, as of 31 December 1946, \$7,965,929. The contractor's fixed fee was \$162,472, included in the total.

~~SECRET~~

4-4. Plant at Alabama Ordnance Works.

a. Contracts. The prime construction contract was the same cost-plus-a-fixed-fee supplement to the Ordnance Contract with the du Pont Company which covered design and engineering. Subcontracts were let for special parts of the work.

b. Description. Except for the omission of the electrolytic finishing building and except for differences in sizes of buildings, the new plant buildings here were similar to those at Morgantown. An Area Gate and Guard House and a warehouse or shop were also constructed. No new power house was built, but some additional equipment was installed in the existing Power House; some was also installed in the existing Pump House. For the most part the existing utilities, with necessary extensions and connections, serve the new plant, but a new septic tank was installed for the sewer system.

c. Progress. Construction started 11 February 1943 and was completed (exclusive of some revisions not considered a part of the original work) 15 November 1943, with no material delays. The first unit of the plant was placed in initial operation 29 May 1943 and the last unit 4 September 1943.

d. Costs, including engineering and design as well as construction and equipment, but not including any costs incurred under OSRD contracts, totalled, as of 31 December 1946, \$3,319,827. The contractor's fixed fee was \$70,388, included in the total.

4-5. Recapitulation of Costs.

<u>Plant</u>	<u>Approx. Total Cost</u>
Trail Plant (including OSRD Expenditures from War Department Funds)	\$2,604,622
Morgantown Plant	3,475,206
Wabash River Plant	7,888,928
Alabama Plant	5,519,927
OSRD Expenditures from War Department Funds for Plants in U. S.	62,150 <u>\$17,347,333</u>

The estimates of cost of the three plants in the United States, as stated in their respective contracts, exclusive of fees, totalled, combined, about \$28,000,000. This may be compared with the sum of the actual costs of these three plants, including fees (but excluding other expenditures), as listed above, \$14,681,051.

5. Operation.

5-1. Plant at Trail, B. C.

a. The Contract for operation of the manufacturing plant was made with the Consolidated Mining and Smelting Company, as operator, and the contract for operation of the addition to the steam plant was made with the Canadian Government, the C. M. & S. Co. serving as intervenant. The contract for operation of the manufacturing plant provides, in general, for the C M & S Company to operate the plant and for the U. S. to pay all operating costs, without profit, for the product obtained; the contract contains detailed provisions and conditions, concerned in part with the necessary concurrent operation of the contractor's electrolytic

~~SECRET~~

ammonia producing plant, and providing for four successive periods which might extend some 26 years after the cessation of hostilities in the present war; a Period One, or first period of operation; a Standby Period; a Second Period of Operation; and a Lease Period. During the final lease period, which is to be 21 years, the C M & S Company has the right to purchase the plant, under certain conditions; if the company does not exercise this right, the United States is to dismantle the plant and restore the C M & S Company premises to their previous condition.

The C M & S Contract was modified, effective 1 September 1946, from a cost-plus to a unit price basis. The original C M & S P-9 Contract provided for the contractor's privilege to use all production during the "standby period" and 50% of all production in the "second period of operation". Since the Government desired to retain control of all material during these periods, it was necessary to devise a modification of the contract in which the contractor agreed to turn over complete production to the Government on a unit price basis. The unit price was established such that the Government paid the contractor's price of \$78.72 per pound for the entire production in the ninety day standby period following 1 September 1946 and \$53.44 per pound for the entire production during the second period of operation. The price for the second period of operation was arrived at by averaging 50% of the production at the contractor's price, viz., \$78.72, and 50% at cost-plus-overhead, viz., \$28.00 per pound.

~~SECRET~~

b. History of Operation. The history of operation of the plant at Trail, from the start-up on 16 June 1943 was for the most part a continuous struggle to get into the full production of 1000 lbs per month, originally proposed, as quickly as possible. This goal was finally reached in December 1944 instead of August, the month first estimated. During the period of gradually increasing monthly production, studies were made of the problem of product losses, with the help of the representatives of Columbia University, who had been following the project closely, and various steps were taken to eliminate leakage and improve production.

c. The Production Records show that production increased almost continuously, from 31 pounds per month in July 1943, the first complete month of operation, to 1050 pounds per month in December 1944. Since December 1944 the production at the Trail Plant has averaged more than 1100 pounds per month and the total cumulative production to the end of December 1946 was 86,530 pounds of P-9.

d. Production Costs. The operating costs from July, 1943 to 1 September 1946 averaged about \$25,221 per month. In this time the unit cost per pound of P-9 Product had decreased from \$1010 per pound in August, 1943 to \$24 per pound in August, 1946. After 1 September, 1946 the unit cost of the P-9 increased to \$78.72 per pound for the 90-day standby period and \$53.44 per pound thereafter. This increased cost was resultant of the Modification No. 1 to the Trail Contract (See 5-1 a above).

As of 1 September 1948 the total cost, including amortisation of the construction costs based on 120-month plant life, was approximately \$59.00 per pound.

6-2. Plants in the United States.

a. The Contracts for operation of the three heavy water producing plants in the United States are the same three supplements to the respective cost-plus-a-fixed-fee ordnance contracts with the duPont Company previously mentioned as covering design and construction. These contracts provided for minimum monthly operating fees as well as per "unit" (or per ounce) operating fees. These fees, with the "units" translated to pounds are as follows:

<u>Plant</u>	<u>Operating Fees</u>			<u>Minimum Fee Per Month</u>
	<u>For Monthly First Production in lbs of:</u>	<u>Fee per lb</u>	<u>For Additional Monthly Production, Fee Per lb</u>	
Morgantown	800	\$6.08	\$3.20	\$ 2,400
Wabash River	8,400	9.28	4.80	10,700
Alabama	1,600	9.28	4.80	7,000

Monthly fee payments were based on the amount of finished product drawn from the Morgantown finishing plant, equitably proportioned to the three plants, in accordance with the amount of unfinished product supplied by each.

b. The operating Procedure followed provides in general that the Ordnance Commanding Officer at each plant exercises administrative control and the Manhattan District Engineer exercises technical supervision, thereby avoiding duplication of personnel and maintaining desired secrecy and efficiency.

~~SECRET~~

e. History of Operation. For these plants likewise the history of operation, from the respective dates of start-up of full operation, in August and September, 1943, to 1 April 1945, was for the most part a continuous struggle to get into full design production, originally estimated at 4,800 lbs per month. Although it became apparent that this rate was not likely to be fully attained, every effort to increase production was continued, with the help of an independent committee of consultants. Numbers of suggestions were made for eliminating losses and improving production; these were all carefully considered and those which seemed most practicable and promising were tried out. The most important of these was the repair of the plates in the large diameter first stage towers, to reduce by-pass leakage. This improvement was successfully made on a sample pair of towers at Morgantown; the results indicated that similar reconstruction of all first stage towers at all three plants would increase production very materially. By the time that this had been determined, however, at the beginning of the year 1945, it was estimated that an approximate balance between supply and demand for the finished product would soon be reached, and it was decided that the complete reconstruction would not be justified.

The duPont P-9 distillation plants at the Alabama Ordnance Works, Wabash River Ordnance Works and Morgantown Ordnance Works were shutdown in June, July and August, 1945, respectively. The electrolytic finishing plant operations at Morgantown Ordnance Works were terminated in September, 1945. In cases considered economically feasible, intermediate products drained from these plants were forwarded to Trail and introduced into the Trail Operations, resulting

617
~~SECRET~~

in a net increase in production at Trail of approximately 1600 pounds of P-9 while normal Trail operations and operational costs remained undisturbed.

d. The Production Records show that 2488 lbs of heavy water were produced at the Morgantown electrolytic finishing plant (from the unfinished product of all three distillation plants) during the month of February, 1944. From that month to August, 1945 the monthly production has varied between 1995 lbs to 3020 lbs, except during the month of August, 1944, when production dropped to 1299 lbs because the experiment was tried of temporarily discontinuing drawing off from the distillation plants in the hope that the efficiency would be increased by building up internal concentrations. The average monthly production from February, 1944 through August, 1945 was 2877 lbs and the total cumulative production for this period was 43,263 pounds. This does not include 726 pounds of special product (90% enriched) and 3151 pounds of material recovered in Germany and reworked to product specifications in the finishing plant.

e. Production Costs. The production costs for the period February, 1944 to the time when each plant was placed in standby averaged approximately as follows:

<u>Plant</u>	<u>Average Monthly Production Cost</u>
Morgantown Ordnance Works	\$72,000
Wabash River Ordnance Works	197,400
Alabama Ordnance Works	<u>154,000</u>
Total	\$423,400

The average production cost per pound during this period was

~~SECRET~~

approximately \$186. If plant amortization based on 120-month plant life is included, this production cost would be approximately \$316 per pound; or if full amortization of the total construction costs is included, the cost would average about \$550 per pound.

5-3. Recapitulation.

a. Production Records. The total cumulative production to the end of December, 1945 for all four heavy water plants was 81,470 pounds of P-9 Product. This figure does not include 726 pounds of special product nor 3151 pounds of German product reworked to P-9 product specifications at Morgantown Ordnance Works. At present the total production is increasing at the rate of approximately 1100 pounds per month. The fact that performance did not meet expectations (with respect to the date of attainment of designed production, at the Trail Plant, and with respect to both the maximum rate of production and the date of its attainment, at the plants in the United States), was due principally to the novelty of the material and the processes. The scientists and engineers merely set their sights somewhat too high and as they were dealing with a comparatively new material and comparatively new processes never before attempted for quantity production, this is not surprising. The constant efforts of all concerned to increase production and their success in attaining the production actually needed are noteworthy.

b. Production Costs for all four plants combined, cumulative to 31 December, 1945 were about \$11,967,000. This total is increasing at a monthly rate of about \$69,000 plus \$1,776 required to maintain

~~SECRET~~

the United States plants in stand-by.

c. The estimated Total Cost per Pound of Product, from all four plants combined, including amortization of construction costs of the Trail, B. C. plant based on 120 months plant life, is approximately \$204. If the entire construction costs are assumed to be amortized as of the end of December, 1946, this total cost per pound of Product is approximately \$356. This represents a mean cost of \$550 per pound for the three plants in the United States and \$111 per pound for the plant at Trail. The lower cost of the hydrogen-water exchange plant at Trail is resultant to a considerable extent from the fact that hydrogen was already being produced at that plant, with facilities already existing.

5-4. Shipments of Material, in partially concentrated form, were made from the Alabama and Wabash River distillation plants to the Morgantown electrolytic plant by Railway Express under "Money" receipts, in sealed, special metal containers. Deliveries to and from the Express offices were made by special truck. Shipments of the finished product from the Trail Plant and from Morgantown, to the University of Chicago, respectively, are and were handled similarly by Railway Express.

6. Organization and Personnel.

6-1. Administration. In another book the Government organization and personnel for the overall administration of this project, including the parts played by the OSRD, the S-1 Committee, and the Military Policy Committee are set forth. The project

functioned under the direction of Major General L. R. Groves, with the Manhattan District carrying out his general instructions. From 20 July 1943, Colonel K. D. Nichols was District Engineer of the Manhattan District, succeeding Colonel J. C. Marshall on that date. A separate unit of the Manhattan District, under Major H. S. Traynor, was in charge of the development and production of the product, with separate officers in general handling the construction work and the operation work at each plant.

6-2. Research and Development Personnel were headed by Dr. H. C. Urey, at Columbia University. Some of the work was also carried on at Princeton University, Northwestern University and the University of Minnesota, and by Universal Oil Products Company and the du Pont Company.

6-3. Design Personnel included principally, for the plant at Trail, Dr. C. H. Wright of Consolidated Mining & Smelting Company and Mr. A. L. Hartridge, of Stone and Webster Engineering Corporation; and for the plants in the U. S. Mr. E. G. Ackart, Mr. Granville M. Head, Mr. Tom C. Gary, and Mr. V. R. Thayer of E. I. du Pont de Nemours and Company.

6-4. Construction Personnel included principally: Mr. H. F. Teidje of C M & S Co. at Trail, B. C.; Mr. E. G. Ackart and Mr. Granville M. Head of the du Pont Company for the plants in the U. S.

6-5. Operating Personnel included principally: Dr. C. H. Wright, of C M & S Co. at Trail, B. C.; Dr. J. A. Monier, Dr. W. P. Bebbington and Mr. V. R. Thayer of the du Pont Company, in charge of general technical supervision of operation at the three plants in the United States. A total of 45 employees are now operating the Trail plant.

A special committee of consultants was called upon to advise in connection with the operation of the plants in the United States, and this committee was headed by Dr. W. K. Lewis of Massachusetts Institute of Technology.

6-6. General. To the loyalty, cooperation, skill and hard work of all those named above, as well as many others, too numerous to mention, is due the successful attainment of the purpose of this project.

~~SECRET~~

MANHATTAN DISTRICT HISTORY

BOOK III - THE P-9 PROJECT

SECTION 1 - GENERAL

1-1. Purpose.

a. The purpose of the P-9 Project (the term used to designate the heavy water project) as determined at the outset, was the provision of "heavy water" or deuterium oxide for the following uses:

(1) As an essential material to be used in developing a "heavy water" method of manufacturing plutonium. This was an alternate process, or insurance, in the event that the "graphite" full-scale production method (making use of graphite instead of heavy water) encountered unpredictable and delaying obstacles which could not be overcome in time for the end product to be of use during the war.

(2) As a material whose scientific possibilities, which the enemy might uncover, had yet to be fully explored. It was known that the Germans were making serious efforts to produce heavy water.

b. This purpose has been successfully attained. The product has been manufactured by two different processes. One of these processes has been carried on at an existing electrolytic hydrogen plant owned by the Consolidated Mining & Smelting Company, Ltd., at Trail, British Columbia, Canada.

~~SECRET~~

~~SECRET~~

The other process has been carried on at three of the U. S. Government's existing Ordnance plants: The Morgantown Ordnance Works, Morgantown, West Virginia; the Wabash River Ordnance Works, Newport, Indiana, and the Alabama Ordnance Works, Sylacauga, Alabama.

c. Although the construction of new plants, or parts of plants, for production of the desired material was required in each case, the partial use of existing industrial facilities reduced this construction to a minimum and effected very material savings in overall costs. The plant which was installed at Trail, B. C., in effect makes use of hydrogen already in production, borrowing it from the C M & E Company for the new process and then returning it again to that company for its ammonia production, minus a constituent which they did not need; each of the three other plants made use of steam for which the equipment was already available or could be installed with a minimum of new construction. Many additional facilities (utilities, services, etc.) which were already in existence before the new plants were installed have also been used to advantage, as will be noted hereinafter.

d. The material produced has been used in a joint project with our allies and the material and the methods of its production remain available as "insurance" in connection with other known uses. The potential future uses of the product are still unaffected; the scientific knowledge and data available to the Government have through the prosecution of this project been increased immeasurably;

~~SECRET~~

the chances of the enemy outstripping the science of this country have been correspondingly decreased. In this connection--in evaluating the overall purpose and accomplishments of the project--it is well to look into the future. Regardless of what final plans for continuing peace may be developed, it is certain that peace for this country can be made secure only if the Government maintains a leading position in the development of potential new war materials and war methods.

1-2. Authorization.

a. All action in connection with the institution and prosecution of this project was taken under authority granted by Congress in the Acts which are described in another book (Book I); the funds used were likewise appropriated by Acts there described.

b. Under the authority vested in him by these Acts, the President issued orders and authorizations which are described in the same book (Book I).

c. Major General L. R. Groves directed or authorized the general policies and directives under which the Manhattan District carried out the work. The S-1 Committee of the OSRD and the Military Policy Committee registered their general approval of the basic decisions involved, as recorded in the minutes of meetings or in other documents in the project files. (Appendix E1; See also Section 6, Organization and Personnel).

~~SECRET~~

SECTION 2 - RESEARCH AND DEVELOPMENT

2-1. Basic Theory.

a. Before this project was undertaken science had already determined that natural water is composed of "light" water and deuterium oxide or "heavy" water; that natural hydrogen likewise has two components, "light" hydrogen and deuterium or "heavy" hydrogen, and that these are isotopes; and that when "heavy" hydrogen is burned with normal oxygen it forms "heavy" water.

b. Science had also determined, to the degree of accuracy theretofore attainable, that both "heavy" water and "heavy" hydrogen are present in the ratio of roughly one part in 7000, or .015%, in natural water and natural hydrogen respectively. Prior to the extensions of scientific knowledge which developed from this project, it was generally assumed that the "heavy" water concentration was the same in all natural waters; but the recent research has led to the theory--not yet accepted by all--that this ratio varies and that some natural waters contain more heavy water than others. The total range of the variations is so close to the range of errors in measurement by the means so far devised, that this theory of variations has not yet been generally accepted. Correspondingly, these variations seem too small to produce appreciable effects in the manufacturing processes, although it was at one time thought that the use of a natural water having a low heavy water content might be a serious handicap.

c. The problem presented, for solution by those in charge of research and development, was, broadly speaking, the production of

~~SECRET~~

heavy water by one or more of several possible means: by separation from natural water; or by production of heavy hydrogen and formation of heavy water therefrom; or by some other method which might be developed.

2-2. Specific Research Projects.

a. In the summer of 1942, certain portions of the S-1 work, concerned with the development and production of uranium--including heavy water production--were transferred from the OSRD to the War Department. (See App. D2) At that time a considerable amount of heavy water research and development work had already been started under contract, including specifically the following more important projects (See App. C1 for Reports and App. C2 for Contracts):

(1) Investigation for construction and operation of a pilot plant for the production of heavy water. This work is described in Technical Reports Nos. S97, dated 24 November 1942, and S-108, dated 16 December 1942, and is covered by Contract OEMsr-166, with Standard Oil Development Company, dated 8 December 1941, effective, with its supplements, for the period 1 August 1941 to 31 December 1942.

(2) Investigation of suitable catalysts for use in heavy water production plants. This work is described in Technical Report No. S-108, dated 16 December 1942, and is covered by Contract OEMsr-407, with Standard Oil Development Company, dated 23 May 1942, effective, with its supplements, for the period 21 January to 21 July 1942.

(3) Separation of heavy water. This work is described in Technical Report No. A-1933, dated 28 February 1944, and

is covered by two contracts, with Columbia University: OEMsr-107 dated 29 October 1941, effective, with its supplements, 1 July 1941 to 31 July 1942; and OEMsr-412, dated 23 May 1942, effective, with its supplements, for the period 1 December 1941 to 31 August 1944. The latter contract was superseded by War Department Contract No. W-7405 eng-50, on 1 May 1943.

(4) Development of continuous deuterium analytical apparatus and determination of deuterium content of water samples. This work is described in Technical Reports Nos. A-359, dated 4 November 1942, and A-527, dated 1 February 1943, and is covered by Contract OEMsr-482, with Northwestern University, dated 18 June 1942, effective, with its supplements, for the period 1 May 1942 to 31 January 1943.

(5) Studies, cost estimates, preliminary engineering work on a large-scale heavy water production plant and experimental investigations, especially on the tests of catalysts. This work is described in Technical Report No. A-608, dated 2 December 1942, and is covered by Contract OEMsr-797, with Consolidated Mining & Smelting Company of Canada, Ltd., dated 4 January 1943, effective, with its supplements, for the period 1 February to 30 September 1942.

(6) Studies and experimental investigations in connection with the mass spectrograph, and construction of a number of spectrometers. This work is described in Technical Report No. A-797, dated 20 October 1943, and is covered by Contract OEMsr-149, with the University of Minnesota, dated 19 November 1941, effective, with its supplements, for the period 1 July 1941 to 30 June 1943.

~~SECRET~~

b. Further research was instituted after the transfer to the Manhattan District, including particularly the following additional specific projects:

(1) Studies and experimental investigations in connection with the development of nickel or other catalysts for promoting exchange reactions. This work is described in Technical Reports Nos. A-501 (Columbia Serial No. 100 XR-26), dated 14 January 1943, and A-534, dated 13 February 1943, and is covered by Contract OEmSr-693, with Universal Oil Products Co., dated 15 October 1942, effective, with its supplements, for the period 10 September 1942 to 31 March 1943.

(2) Engineering studies for the development of a method of producing heavy water from ammonia by the "direct method". This work is described in Technical Report No. A-394, dated 4 December 1942, and is covered by Contract OEmSr-776, with E. I. du Pont de Nemours & Company, Wilmington, Delaware, executed by the Director of OSRD upon the recommendation of the S-1 Committee on 26 September 1942. This contract was dated 8 December 1942, effective for the period 1 October 1942 to 1 April 1943.

(3) Studies for the development of a method of producing heavy water by the solvent extraction of natural water with triethylamine. This work is described in Final Report No. A-1916, dated 15 December 1943, and is covered by Letter Contract No. W-7412 eng-68, with the du Pont Company, dated 19 July 1943, superseded by the correspondingly numbered lump sum contract dated 15 March 1944.

c. A number of other studies and experiments had also

~~SECRET~~

been carried on, but the above represent those which were the most comprehensive and important. A list of technical reports appears in Appendix C1.

2-3. General Investigations.

a. The OSRD had obtained statistics, in 1941, of all existing hydrogen producing plants on this continent, for the purpose of determining which was best suited for use in conjunction with one of the proposed processes for manufacture of heavy water (App. D3). It was found that the plant of the Consolidated Mining & Smelting Company of Canada, Ltd., located at Trail, B. C., was the only one in either the United States or Canada in which the hydrogen was manufactured by the electrolytic method in the required quantities. This automatically determined the location of one of the heavy-water producing plants, as described hereinafter, and precluded the possibility of rapid development of production by the same process anywhere else.

b. Early investigations had shown that hydrogen manufactured by the coke and natural gas processes was deficient in "heavy" hydrogen, a basic component of heavy water. At this time hydrogen manufactured by the electrolytic method was considered the most suitable for producing heavy water, and therefore the research in connection with the production of hydrogen, for use in the production of heavy water, was then confined to the electrically produced gas only.

2-4. Decisions Required.

a. Based upon the knowledge and data obtained from the research work, the following major decisions were required:

- (1) What process or processes should be fully developed and used in manufacture;
- (2) To what production capacities selected processes should be developed;
- (3) Where the manufacturing plants should be located.

b. During the course of reaching decisions on these points, it was inevitable that there should be differences of opinion among the consultants and others upon whom the responsibility rested; and the exigencies of the war, with the over-powering necessity to save every possible day of time, would not permit the lengthy investigations both in and out of the laboratory which a normal peace-time program would have demanded. Nevertheless, every available argument pro and con was developed and carefully weighed, in conference after conference, and the decisions conformed clearly to the overall results of these discussions. Generally unanimous agreement was reached on all the most important actions.

2-5. Processes Considered.

a. Careful consideration was given to every one of the known or assumed possible methods of producing heavy water. The choice was finally narrowed down to the following four processes:

- (1) The "hydrogen-water exchange" process by which deuterium was concentrated in a catalytic exchange reaction between hydrogen

gas and water vapor. Special consideration was given to this process because of the availability of a pure hydrogen, generated electrolytically for the manufacture of ammonia at Trail, B. C. This process was generally recognized to be in a more advanced state; therefore, more certain in its results than any of the others. (See App. C1: S-97, A-608, S-108, and A-1933).

(2) The "water distillation" process, or "W" process (App. C1: A-501, A-544, and A-1933).

(3) The "hydrogen sulphide-water duotemperature exchange" process, or "S" process. This was recognized as being still in the early experimental stages; and therefore, less certain in its results than either of the two preceding processes, but it was regarded as very promising; studies for its development were continued, with the approval of the S-1 Committee, even beyond the time that decision was made to adopt other processes. This process was not adopted because of its continued uncertainty and because the information available indicated that it would take more time to develop, that it would be more costly, and that it would require greater quantities of critical materials, principally stainless steel. Probably the most serious and doubtful problem involved in this process was the protection of equipment against the corrosive effects of the water-hydrogen sulphide mixture; it was believed that the addition of inhibitors or the use of a protective coating of "Heresite" would solve this problem and reduce the need for stainless steel, but adequate long-time tests were still required to prove the efficiency

~~SECRET~~

of either of these actions. (App. C1; A-741; App. D4, D5, and D6).

(4) The "triethylamine" process. Preliminary laboratory research at Columbia University and at the Massachusetts Institute of Technology had indicated that heavy water might be produced economically by this process and that this process might be carried out in plants constructed for production of heavy water by water distillation, with but little modification. Final Report No. A-1916 showed, however, that the use of triethylamine was not feasible and consequently research on the process was finally abandoned.

b. Nomenclature.

The nomenclature of these processes, comparatively new as they are, has not yet become standardised; therefore some of the processes may be referred to in the records by names other than those used herein. The names here used are the most informative, however, and it is believed that they can be readily identified by the context when referred to by other names.

2-6. Principal Decisions.

a. Decision for Trail Plant.

To install facilities at the existing ammonia plant of the Consolidated Mining and Smelting Company, in Trail, B. C., for the production of heavy water at an estimated rate of 0.5 tons per month, by the "hydrogen gas" process, using natural water from the Columbia River and the hydrogen which was already in production at that plant. (App. D1).

(1) Once the determination had been made to select this type of process, the decisions as to location and rate of production were dictated almost automatically by the conditions. As

~~SECRET~~

~~SECRET~~

previously noted, Trail was the only location where electrolytically produced hydrogen was already available, and estimates indicated that production of 0.5 tons per month could be expected without undue extensions to existing facilities.

(2) To implement this decision, the following first steps were taken:

(a) The O.S.R.D. issued a Letter of Intent to Consolidated Mining and Smelting Company of Canada, Trail, British Columbia, dated 25 February 1942, to make expenditures up to \$5,000 for studies and investigations with regard to electrolysis for a heavy water plant.

(b) The OSRD issued a Letter of Intent to Consolidated Mining and Smelting Company, dated 1 May 1942, to make additional expenditures up to \$50,000 for studies for a heavy water plant and changes in their existing plant and for experimental investigations, including tests of catalysts.

(c) The OSRD entered into Contract No. OEMsr-797, with Consolidated Mining & Smelting Company, dated 4 January 1943, confirming and superseding both of the two Letters of Intent described in paragraphs (a) and (b) above and providing for total payment of \$55,000, the sum of the two payments thereunder. This contract provided for the conduct of studies and preliminary engineering on a large scale plant for manufacturing heavy water or P-9, the conduct of investigations and the reporting of results; it was effective for the period from 1 February to 30 September 1942. This work is

~~SECRET~~

described in Technical Report No. A-608, dated 2 December 1942.

(d) The OSRD authorized E. B. Badger & Sons Company, 75 Pitts Street, Boston, Massachusetts, in May 1942, to proceed with the engineering and design of an "exchange unit" for a heavy water plant at Trail, B. C. (This authorization was later confirmed by lump sum subcontract No. 22 (C-819), dated 15 July 1942, between Stone and Webster Engineering Corporation and the Badger Company.) (App. D7).

(e) Shortly after the project was taken over by the Manhattan District, Stone & Webster Engineering Corporation assumed the duties of furnishing the general architectural, engineering, construction and managerial services for the work at Trail, B. C., as a part of their overall architect-engineer-construction-management services for the Manhattan District, under Contract No. W-7401 eng-13, dated 29 June 1942.

b. Decisions for Plants in U. S.

To install supplementary facilities at three existing Government Ordnance Works for the production of heavy water at an estimated combined rate of 2.4 tons per month (Morgantown Ordnance Works, 0.4 tons per month, Wabash River Ordnance Works, 1.2 tons per month; Alabama Ordnance Works, 0.8 tons per month) by the "water distillation" process, using steam to be obtained insofar as possible from excess steam available at the plants, to be supplemented if necessary by the construction of additional steam generating facilities, and using natural water from a local source in each case.

~~SECRET~~

(App. D8, D9).

(1) The problem of determining how much of the product should be scheduled for production at these plants was a difficult one, and at different times different quantities were under consideration, varying in summation from 2 to 5 tons per month. The total amount of heavy water which would be required was unknown. It would depend upon the final choice of method for producing plutonium and this likewise was unknown at the time the decisions had to be made. The only thing that could be done was to exercise considered judgment and schedule such quantities as seemed most reasonable, and sound decisions were reached. The predetermined schedules (calling for a total of 2.4 tons per month at the three Ordnance Plants combined, or 2.9 tons per month at all four plants combined) have produced quantities which have proved to be sufficient for all necessary research and experimentation and they have enabled the War Department to obtain the necessary design and operating experience for such future expansion as may some day be necessary.

(2) In determining the plants at which this process should be developed and carried on, many existing Ordnance Plants were considered (including especially those Ordnance Plants in the natural gas area between New Orleans, Louisiana, and Corpus Christi, Texas), in order to determine those locations at which the greatest advantage to the Government could be obtained from existing materials and existing facilities. It is believed that this advantage was secured at the sites selected.

~~SECRET~~

~~SECRET~~

(3) To implement these decisions, the following first steps were taken: The Manhattan District issued Letter Contract No. W-7412 eng-4, dated 16 November 1942, to the du Pont Company. This contract provided for the design, construction and operation of a plant for the production of heavy water, in addition to studies, etc., from which the type of plant was to be determined. In accordance with this contract, at a conference on 29 December 1942, with General L. R. Groves and Colonel K. D. Nichols, the decisions were reached to proceed with the design and construction of facilities for production of heavy water at the three Ordnance Works and in the approximate quantities above described. On 31 December 1942, a supplement to Letter Contract No. W-7412 eng-4 was issued, authorizing expenditure of \$15,000,000 instead of \$5,000,000, the original tentative figure.

(4) The du Pont Company was selected for this work principally for the following reasons: (a) they were splendidly equipped with facilities, organization and personnel well qualified for blazing new trails in the development of new processes of manufacture, (b) they were already recognized as leading designers, builders and operators of munitions plants, (c) they were already engaged on the construction of the three Ordnance Plants in question.

(5) The du Pont Company agreed—with some hesitation—to undertake the work, despite the difficulties involved and despite

~~SECRET~~

the lack of any specific knowledge, largely because of their recognition of the importance of the work as a war project.

2-7. Specifications of the Product.

a. Exact specifications of the product were not established before arrangements were made for construction and operation of the proposed plants for production of heavy water, because at that time the exact standards required were unknown. It was agreed, however, that the final product would have a concentration of heavy water in the neighborhood of 99% to 100%.

b. At a conference in New York on 18 November 1943, between representatives of the Metallurgical Laboratory of the University of Chicago, the du Pont Company and the Manhattan District, tentative specifications were agreed upon and it was decided that final specifications would be determined by the Metallurgical Laboratory, University of Chicago, as the organization most concerned with standards of purity and concentration. (App. D10).

c. Subsequently, the following specifications for the finished product were adopted (App. D11 and D12):

- (1) The minimum concentration of heavy water for any shipment of product after correction for O_{18} content shall be 99.7%.
- (2) The minimum average concentration of heavy water for all shipments of product from each plant shall be 99.75%.
- (3) All finished product shall have pH of 6.0 to 6.6.
- (4) No adjustment of O_{18} isotope shall be made in any product unless it exceeds ten times normal concentration.

~~SECRET~~

~~SECRET~~

(5) No specific limitation need be placed on impurities, in view of the several distillations provided in each plant during the process of manufacturing the final product, expected to reduce impurities to insignificant proportions.

d. No specifications were fixed for the semi-finished product, as drawn from each of the three distillation plants at the Ordnance Works, before processing in the electrolytic plant at Morgantown (as described hereinafter). It was felt that it would be most unwise to set any specific standards, for concentration of heavy water or other qualifications, as this might easily handicap production. The characteristics of the semi-finished product were accordingly left for determination by the operator, as dictated by operating conditions, and specifications were fixed for the final product only, as it was drawn from the electrolytic plant. As a matter of fact, the concentrations to be attained in the semi-finished product underwent changes during the period of operation. Those concentrations obtained at the time the three water distillation plants were placed in standby was about 85% to 90%.

~~SECRET~~

~~SECRET~~

SECTION 3 - DESIGN AND ENGINEERING

3-1. Plant at Trail, B. C.

a. Site.

(1) Description (App. D13).

(a) The Trail plant is located on the property of the Consolidated Mining and Smelting Company of Canada, Ltd., in the Trail Area, Kootenay District, Province of British Columbia, Dominion of Canada. Trail is about seven miles north of the Washington State border, International Boundary, and about 102 miles north of Spokane, Washington.

(b) The Canadian Pacific Railway serves the area, with previously existing track facilities direct to the project site. The principal roads entering the city are: a continuation of U. S. Route No. 395 from Spokane to Kettle Falls and Washington Route No. 22 from Kettle Falls northward, crossing the Canadian border near Patterson; and the Southern Trans-Provincial Highway, B. C. Route No. 3, entering Trail from Nelson, British Columbia.

(c) Trail is located in the Columbia River Valley basin with the mountains of the Selkirk Range towering around the city. The principal industry of the region consists of the mining, smelting, chemical and fertilizer works of the C.M. & S. Company.

~~SECRET~~

(d) The works of the C. M. & S. Company have two main locations in the Trail Area; the smelter at Tadanac, B. C., immediately north of Trail, and the chemical and fertilizer division at Warfield, B. C., about 2 miles west of Trail. Most of the new construction work was performed at the Warfield site, which is a broad level plateau about 630 feet above the Columbia River. The principal soil type on this plateau is sand, and no unusual foundation problems were encountered.

(e) The principal advantages of this site were: the existing plant facilities of the C. M. & S. Company, including particularly the hydrogen gas available from their own ammonia manufacturing process, as well as existing structures, utilities, etc.; and the benefit of the experience of the personnel of the C. M. & S. Company in connection with design, construction and operation of the new plant.

(f) The only disadvantage of this site was its location outside the boundaries of the United States. As previously noted, however, this was the only existing plant on this continent at which electrolytically produced hydrogen was available in the required quantities. The advantages of this site far out-weighed its disadvantage.

(2) Lease Arrangements.

(a) Under the terms of the contract between the United States Government and the Consolidated Mining & Smelting Company hereinafter described all alterations to C. M. & S. owned

facilities remain the property of that company and title to all new facilities erected on company owned property are vested in the United States Government. (App. C2: W-7405 eng-10).

(b) The land upon which the new construction was placed has been leased to the U. S. Government, in six parcels by the C. M. & S. Company, and in a seventh parcel by the Allied War Supplies Corporation, an agency of the Canadian Government. (App. C2: W-7418 eng-70). No rental is paid for this land other than the general considerations specified in the contract. The seven parcels may be tabulated as follows:

<u>Parcel No.</u>	<u>Occupied by</u>	<u>Leased From</u>	<u>Ground Area in Sq. Ft.</u>
1.	Booster Bldg.) Evaporator Bldg.) Tower Structure)	CM&S Co.	7,363
2.	Secondary Plant	CM&S Co.	5,388
3.	Cooling Tower) Pump House)	CM&S Co.	3,060
4.	Assay Laboratory	CM&S Co.	850
5.	Oxygen Tower	CM&S Co.	195
6.	Catalyst Shed	CM&S Co.	1,120
7.	Steam Plant	ANS Corp.	<u>2,688</u>
TOTAL			20,664 or, 0.474 acres

(App. A1 and D14)

b. Contracts.

(1) The contracts for design and engineering in connection with the plant at Trail were as follows:

(a) Fixed Fee Architect-Engineer-Manager Contract, between the U. S. Government and Stone and Webster Engineering Corporation, 90 Broad Street, New York, N.Y., Contract No. W-7401 eng-13,

~~CONFIDENTIAL~~

dated 29 June 1942.

(b) Fixed Fee Architect-Engineer (and Construction) Contract, between the U. S. Government and Consolidated Mining & Smelting Company, Ltd., Trail, B. C., Canada, Contract No. W-7405 eng-10, dated 31 July 1942.

(c) OSRD Contract OEMer-797 with CM&S Company, dated 4 January 1943, effective for the period 1 February to 30 September 1942. (See Section 2)

(d) Lump Sum subcontract, between Stone and Webster Engineering Corporation and E. B. Badger and Sons Company, 75 Pitts Street, Boston, Massachusetts, dated 15 July 1942, No. 22 (C-819), covering design and preparation of finished engineering drawings for complete exchange unit and the procurement of certain equipment and materials therefor.

(2) There was also the following subcontract for design, engineering and consulting services in connection with the production of nickel-chromium, which was proposed as an alternate catalyst for the plant at Trail.

Lump Sum Subcontract, between Stone and Webster Engineering Corporation and Universal Oil Products Company, 310 Michigan Avenue, Chicago, Illinois, dated 21 October 1942, No. 21 (C-818).

e. Procedure.

In general, the engineering and design work was first performed by C M & S Company under their research and development

~~SECRET~~

contract and their construction contract and was then submitted to the Stone and Webster office in Boston for check and review. It was then reviewed and approved by a representative of the OSRD S-1 Committee, by a Manhattan District Area Engineer in Boston and finally by the Manhattan District. The same general procedure was followed for the engineering and design work which was first performed by E. B. Badger & Sons Company.

d. Description of Process. (App. A5 and D15).

(1) Primary Plant. Normal water is fed to the tops of three first stage towers containing alternate layers of bubble cap plates and perforated trays filled with catalyst. Flowing downward through the towers the water comes in contact with hydrogen (produced in a battery of first stage electrolytic cells) passing upward. By means of this contact between the counterflowing hydrogen and water in the presence of a catalyst and in the bubble cap plates, the heavy hydrogen component of the upflowing hydrogen displaces some of the light hydrogen, a component (with oxygen) of the downflowing water, increasing the concentrations of heavy water in the water coming out of the bottoms of the towers. (Normal water going into the tops of the towers is about 0.015 % heavy water).

The water from the bottoms of the first stage towers is fed to the first stage electrolysing cells where, by electrical means, it is broken down into hydrogen and oxygen. The hydrogen is then passed through coolers where the entrained water vapor is con-

~~SECRET~~

~~SECRET~~

densed out and the relatively dry hydrogen is fed back into the bottoms of the first stage towers to meet more incoming water and give up some of its heavy hydrogen component. Coming out of the tops of the first stage towers the hydrogen is fed back to the Consolidated Mining & Smelting Company ammonia plant (where it is combined with nitrogen to form ammonia).

The water which is condensed out of the hydrogen coming from the first stage electrolyzing cells is fed to the top of a second stage tower (constructed similarly to the first stage towers) where it meets upflowing hydrogen produced in a battery of second stage cells, and the process, as described for the three first stage towers, is repeated, with the exception that the hydrogen passing out of the top of the second stage tower is fed to the bottoms of the first stage towers.

Third and fourth stage towers (constructed similarly to the first stage towers) and third and fourth stage batteries of electrolyzing cells repeat essentially the second stage process, each returning hydrogen from the top of the tower to the bottom of the tower of the preceding stage.

Vapor condensed from hydrogen produced by the fourth stage battery of electrolyzing cells contains about 2.3% heavy water and is used as feed for the secondary plant. All of the hydrogen from which a portion of the heavy hydrogen has been extracted is returned to Consolidated Mining & Smelting Company for the manufacture of ammonia.

~~SECRET~~

~~SECRET~~

(2) Secondary Plant. The secondary plant consists essentially of three stages of batteries of electrolyzing cells. Water (containing approximately 2.3% heavy water) is drawn from the primary plant and fed to the first stage cells of the secondary plant where it is broken down electrically into hydrogen and oxygen. The hydrogen and oxygen are then burned (reformed into water) and fed back to the primary plant. The liquid remaining in the cells becomes increasingly concentrated with heavy water, as this component tends to remain in the cells and the light water component tends to be broken down into hydrogen and oxygen and to leave the cells.

Liquid from the first stage cells, after being chemically treated, is fed to a battery of second stage cells where the process described for the first stage cells is repeated, with the exception that the hydrogen and oxygen drawn off from the cells are burned and returned to the first stage instead of to the primary plant.

The third stage cells draw liquid from second stage cells and perform the same type of process. Liquid drawn from the third stage cells is the finally concentrated product, approximately 99.8% heavy water.

(3) Catalysts.

From the early research and development work in the laboratories it had been indicated that the most promising materials to use for catalysts with the catalytic exchange method of producing heavy water were: first platinum-charcoal for best results; and

~~SECRET~~

~~SECRET~~

second, nickel-chromium which appeared to be somewhat less effective.

(a) Platinum-charcoal. A catalyst of platinum on charcoal which gave evidence of being suitable for commercial production had been developed by research at Princeton University, under a subcontract of OSRD Contract OEMsr-412 and Manhattan District Contract No. W-7405 eng-50. J. T. Baker & Company, Inc., 113 Astor Street, Newark, N.J., had been associated with this development program; they had produced in small particle form a catalyst of this type which had proved successful in laboratory tests, and this Company appeared to be fully qualified to supply the necessary quantity of acceptable material for the P-9 project at the Trail plant.

Accordingly decision was reached at a conference on 13 October 1942, to procure an initial charge of 1,000 cu. ft. of the platinum-charcoal catalyst, designated as "Product 43", from J. T. Baker & Company, through Stone & Webster procurement channels. There were present at this conference representatives of the S-1 Committee of OSRD, of Columbia University, of J. T. Baker & Company, of Stone and Webster, and of the Manhattan District. This decision was made despite the fact that there was still some question as to whether or not this catalyst would become poisoned or lose its activity in long duration production service. The initial charge was procured under Purchase Order No. 44, dated 3 November 1942, between Stone & Webster Engineering Corporation and J. T. Baker & Company.

~~SECRET~~

~~SECRET~~

Later, an additional 36,000 lbs. or a second complete, or reserve, charge of the platinum-charcoal catalyst was procured under direct contract negotiated by the Manhattan District, with J. T. Baker & Company, Contract No. W-7407 eng-6, dated 29 March 1943. This second procurement action was taken upon the recommendation of the OSRD consultant and after a detailed investigation by the Manhattan District. The decision was based on the fact that production of the alternate catalyst, nickel-chromium, referred to in the following paragraphs, had been proceeding slowly and there was some fear that it would not be completed in time for the start-up of the Trail plant.

(b) Nickel-chromium. The development and procurement of an alternate catalyst was believed to be essential, as catalytic operation at the Trail plant was imperative and it was impracticable to determine fully in advance what the usable life of the platinum catalyst would be. For this reason subcontract No. 562,612 of Contract OEMsr-412 had been made with the Universal Oil Products Company, to develop the Columbia nickel-chromium catalyst.

As a result of decisions reached at another conference on 14 October 1942 (the day following the conference previously described) at which representatives of the S-1 Committee of OSRD, of Columbia University, of Harshaw Chemical Co., of Universal Oil Products Company, of Stone & Webster, and of the Manhattan District were present, the following actions were

~~SECRET~~

taken:

(1) The Universal Oil Products Company, 310 Michigan Avenue, Chicago, Illinois, was engaged by Stone & Webster Engineering Corporation, under lump sum subcontract No. 21 (C-818), dated 21 October 1942, previously described, for design, engineering and consulting services in connection with a reduction plant for production of the material at the plant of the Harshaw Chemical Company. The Universal Company was selected because they had accumulated considerable experience on the problem as consultants to the OSRD in the preliminary stages of this project.

(2) The Harshaw Chemical Company, 1945 East 97th Street, Cleveland, Ohio, was engaged under Contract No. W-7405 eng-16, dated 3 November 1942, and Supplemental Agreement No. 1, dated 6 May 1943, negotiated directly by the Manhattan District, for the production of the catalyst (designated as "Product No. 80"), according to specifications and directions furnished by the District Engineer. The Harshaw Company was selected because they were well known specialists in the commercial catalyst field and possessed facilities for commercial production with the exception of the reduction equipment. The contract originally provided for production and delivery of 90,000 lbs of the material.

Through the summer and early fall of 1943 operating experience at Trail had shown that the platinum catalyst was entirely satisfactory and gave no indication of becoming poisoned or losing its effectiveness. For this reason,

and because a second charge of the platinum catalyst was already available, the decision was made to discontinue further production of the nickel-chromium catalyst, only about 1900 lbs, or less than 2% of the contract amount, having been delivered up to that time. Accordingly, on 1 November 1943, the contract with Harshaw Chemical Company was terminated and the production equipment was placed in standby condition. (The subcontract with Universal Oil Products Company had been terminated on 3 August 1943, the work called for thereunder having been substantially completed).

e. Costs. Because some of the contracts under which this plant was designed cover also management, construction, etc., the costs of design and engineering have not been segregated. They are included in the other costs set forth in Section 4 hereinafter.

3-2. Plants in the United States.

a. Sites (App. D16, D17, D18).

(1) Morgantown Ordnance Works.

(a) The new P-9 Plant at the Morgantown Ordnance Works is located on the reservation previously acquired by the Government in Monongalia County, West Virginia, about 2 miles south of the city of Morgantown, on the west bank of the Monongahela River, between U. S. Navigation Locks Nos. 10 and 11. The P-9 Plant is in the central part of the reservation, to the south and east of the main manufacturing installations, covering an area of about 2.5 acres, out of the total reservation area of about

~~SECRET~~

826 acres. The principal part of the plant is completely separated from the main manufacturing area by its own fence.

(b) A spur from the Monongahela Railroad and two sidings serve the project; there are also wharf facilities, on the Monongahela River which provides all-seasonal barge transportation as well as a reliable water supply. A concrete access road leads from the project to U. S. Highway 19 at Westover, W. Va., a suburb of Morgantown, and is connected with Morgantown by a concrete highway known as the River Road.

(c) The topography of the area as a whole is hilly. The soil in general throughout the reservation is loam, sand and clay (with occasional rock outcrops in the eastern sections) with shale, coal and rock occurring in insignificant quantities. The most important natural resources of the locality are bituminous coal and natural gas.

(d) Adequate housing facilities for employees were already available nearby in Morgantown and Westover.

(e) The principal advantages of this site were: the existing plant facilities of the Morgantown Ordnance Works, including some existing steam generating facilities in the Ordnance Works power house and other utilities, etc.; the availability of various services and their personnel which were already in operation; and the availability of land already owned by the Government. These factors effected savings in time and in costs which were possible

~~SECRET~~

only at this site and at the other two selected Ordnance sites.

Existing utilities which could be used, at least in part, included: water supply, sewer system, electric system, heating and steam system, compressed air system, telephone system, fire alarm system, roads and walks.

Services which could be used at least in part, included: guards, fire department, personnel office, etc.

(2) Wabash River Ordnance Works.

(a) The new P-9 Plant at the Wabash River Ordnance Works is located on the reservation previously acquired by the Government in Vermillion and Helt townships, Vermillion County, Indiana, adjoining the town of Newport, Indiana, and immediately north of the town of Dana, Indiana. The P-9 Plant is in the northeast portion of the reservation, and the whole project occupies three separate areas, totalling somewhat more than 8 acres, out of the total reservation area of about 21,600 acres. (The fenced in plant area of the Wabash River Ordnance Works covers about 4,500 acres). The three areas are designated as the P-9 manufacturing area, the power area and the water supply area. The P-9 manufacturing area is completely separated from the plant area of the Ordnance Works by a fence of its own.

(b) The entire reservation is Government owned, but outlying parts of it have been leased to local farmers for cultivation.

~~SECRET~~

(c) The plant is served by three railroads; the Baltimore and Ohio Railroad and the Chicago and Eastern Illinois Railroad have each a spur track entering the reservation; the Chicago, Milwaukee, St. Paul and Pacific Railroad has access to the plant under agreement with the B. & O. R. R. for switching to the latter's track at West Dana. Access by highway is provided principally from Indiana State Highway No. 63 on the east; also from the south over U. S. Highway No. 36, from the north over secondary feeder highways and from the west over section roads in Illinois. Indiana State Highway No. 71, which ran through the reservation, furnishes access to the west plant gate.

(d) A portion of the reservation connected with the main area by a corridor about 4/10 of a mile wide, extends to the Wabash River, and the water supply is obtained from wells in this extension, located along the Wabash River. The soil at the site is a fertile loam, overlying clay and gravel, and the surface slopes gently to the southwest. The principal natural resources of the surrounding area are coal, sand and gravel; coal mining and production of sand and gravel are substantial industries. A large part of the land near the plant is fertile and under cultivation in farms averaging less than two hundred acres each.

(e) Ample housing facilities for employees were already available in the neighboring communities of Terre Haute, Danville, Rockville, Clinton and Paris.

~~SECRET~~

~~SECRET~~

(f) The principal advantages of this site were in general the same as those previously described in paragraph (1) (e) above for the site at the Morgantown Ordnance Works.

(3) Alabama Ordnance Works.

(a) The new P-9 plant at the Alabama Ordnance Works is located on the reservation previously acquired by the Government in Talladega County, Alabama, at the junction of the Talladega Creek and the Coosa River, about 14 miles north of Sylacauga, Alabama, 4 miles north of Childersburg, Alabama, and 45 miles southeast of Birmingham, Alabama. The P-9 plant site is in the east central part of the reservation, covering an area, graded approximately level, of about 6 acres, out of the total reservation area of about 13,000 acres. The site of the manufacturing plant is completely separated from the rest of the reservation by its own fence.

(b) The entire reservation is Government owned and was purchased under existing easements. There are no licenses or mineral rights.

(c) There is direct railroad freight service (but no passenger service) to and from the Alabama Ordnance Works, via spurs of the Atlanta, Birmingham & Coast R. R. and the Central of Georgia R. R. Connecting roads directly into the reservation provide adequate accessibility to the highways leading to Birmingham, Sylacauga, Childersburg, and Talladega.

~~SECRET~~

~~SECRET~~

(d) The area is in general gently rolling country with flat lands adjacent to the river. The soil is predominantly a residual clay containing varying amounts of sand, gravel and fragments of rock in varying stages of decomposition, overlying a formation of Dolomitic limestone. Over most of the plant site the upper 15 to 20 feet has a bearing value of about $2\frac{1}{2}$ to 3 tons per square foot. A bearing value of 4,000 pounds per square foot, determined after tests, was used in the design of all foundations. The area contains no natural resources worthy of mention and manufacturing is the principal industry.

(e) Housing facilities for employees were already available at Government housing projects in the neighboring communities of Childersburg, Sylacauga, Talladega and Birmingham.

(f) The principal advantages of this site were in general the same as those previously described in paragraph (1) (e) above for the site at the Morgantown Ordnance Works.

b. Contracts.

(1) Letter Contract No. W-7412 eng-4, with E. I. du Pont de Nemours & Company, Inc., dated 16 November 1942, has already been described in Section 2. This contract provided for design and engineering services, as well as construction.

~~SECRET~~

(2) This contract was later merged in and superseded by three separate Manhattan District - du Pont supplements to existing Ordnance Department - du Pont cost-plus-a-fixed-fee contracts. These supplements were signed by a Contracting Officer appointed by the Chief of Engineers and by a Contracting officer appointed by the Chief of Ordnance, each with respect to his own functions, and they were approved by the Chief of Engineers. They are designated as follows:

(a) Morgantown Ordnance Works. Supplemental Agreement No. 7, dated 11 May 1943, effective 16 November 1942, to Contract No. W-ORD-490, dated 28 November 1940.

(b) Wabash River Ordnance Works. Supplemental Agreement No. 6, dated 11 May 1943, effective 16 November 1942, to Contract No. W-ORD-556, DA-W-ORD-38, dated 12 December 1941.

(c) Alabama Ordnance Works. Supplemental Agreement No. 13, dated 11 May 1943, effective 16 November 1942, to Contract No. W-ORD-526, DA-W-ORD-1, dated 30 June 1941.

(3) Under one of the Titles of each of these Ordnance contracts (Title II for Morgantown, and Title I for Wabash River and Alabama) the du Pont Company, as principal contractor and architect-engineer, performed all design services as well as (under these and other Titles) all procurement, construction and equipment services.

c. Procedure.

(1) A modification of the usual War Department procedure for design and engineering under cost-plus-a-fixed-fee

~~SECRET~~

contracts of the type described above was followed for each of the three plants. In general, the du Pont Company performed the services under the general supervision of the Manhattan District, but under the administrative control of representatives of the Ordnance Department. Efficient cooperation between that Department and the District was maintained throughout the work.

(2) The electrolytic finishing unit was located at Morgantown principally because the Morgantown Ordnance Works was the only one of the three plants which was under the direct operating control of the Ammonia Division of the du Pont Company, which had charge of the P-9 work. This was an advantage in simplifying and facilitating not only the operation of this unit but also its design and construction, and was therefore to the best interest of the Government.

(3) To check design and engineering data, particularly the efficiencies of the plates used in the distillation towers, a series of experiments in the production of heavy water were conducted by the du Pont Company at their Belle Works. A report on these experiments was made to the Manhattan District by letter dated 31 March 1943 (App. D19).

d. Description of Process (App. A6 and D20).

(1) Water Distillation.

The process is carried out in eight stages, each of which has its own distillation tower or towers. As the concentration of heavy water increases from stage to stage the total volume

~~SECRET~~

~~SECRET~~

of material processed decreases and in consequence the diameters and the numbers of the towers in general decrease progressively from stage to stage; the main exception to this general rule is found in the later stages--the fifth, sixth, seventh and eighth--for each of which there is one tower, uniformly of the smallest diameter in the series.

Normal water in the form of condensate from first stage calandrias or heat-exchangers is continuously fed to the tops of the first stage towers.

(The first stage consists of units, each comprised of one 15' diameter tower and one 12' diameter tower, arranged in parallel in a group, or groups, of five. One, three and two of such groups are located at Morgantown, Wabash River and Alabama Ordnance Works respectively).

Passing downward through a series of plates within the towers the water comes in contact with upflowing steam or vapor arising from a quantity of water continuously boiling in the bottom portions of the towers. By this process the down-flowing water tends to pick up the heavy water from the upflowing steam and the water collected in the bottoms of the towers becomes concentrated with the heavy water component. The steam passing out of the tops of the first stage towers is condensed and discarded from the process at Wabash River and Alabama Ordnance Works. At Morgantown Ordnance Works this condensate is delivered to the cooling tower.

~~SECRET~~

The second stage towers operate in essentially the same manner as the first stage except that water partially concentrated with heavy water from the bottoms of the first stage towers is fed to the tops of the second stage towers and steam discarded from the tops of the second stage towers is condensed and fed to the bottoms of the first stage.

The third and succeeding stages operate in the same manner as the second stage, each stage receiving water from and returning steam to the preceding stage. The water collected in the bottoms of the eighth stage towers is drawn off as feed for the secondary electrolytic finishing plant. (The concentration of this semi-finished product from the eighth stage towers was subject to considerable variation during the first ten months of operation. During the last six months of operation the average concentration, from the three distillation plants, was uniformly 89% to 90%.)

(2) Electrolytic Finishing (at Morgantown Ordnance Works only).

Feed water, consisting of about 90% heavy water, from the eighth stage of each of the three water distillation plants, is fed in batches to electrolyzing cells in the electrolytic finishing unit at Morgantown Ordnance Works, where it is broken down by electrical means into hydrogen and oxygen. In this process the heavy water in the semi-finished feed water tends to remain in the cells while the light water is driven off as hydrogen and oxygen. The process in the electrolyzing cells is repeated through several

stages until the liquid remaining in the cells is concentrated to the specified degree, 99.7% or more heavy water. (See Section 2).

e. Costs.

Because the contracts under which these water distillation plants were designed cover also the construction, procurement and equipment, the costs of design and engineering have not been segregated. They are included in the other costs set forth in Section 4 hereinafter.

~~SECRET~~

SECTION 4 - CONSTRUCTION

4-1. Plant at Trail, B. C. (App. D13).

a. Contracts, Orders and Leases.

(1) Prime Construction Contract.

The War Department's Letter Contract No. W-7405 eng-10, dated 31 July 1942, with Consolidated Mining & Smelting Company, Trail, B. C., superseded by a correspondingly numbered cost-plus-a-fixed-fee contract dated 31 July 1942, approved by the Under-Secretary of War, was the principal contract covering the construction of the plant for production of heavy water at Trail. This contract was in addition to OSRD Contract OEMar-797, previously described.

(2) Architect-Engineer-Manager Contract.

The contract with Stone and Webster Corporation, for services including overall supervision of the work, has been described hereinbefore, in Section 3.

(3) Supply Contracts.

The War Department negotiated two supply contracts for catalysts as described in Section 3.

(a) No. W-7405 eng-16, dated 3 November 1942, and Supplemental Agreement No. 1, dated 6 May 1943, with the Harshaw Chemical Company, Cleveland, Ohio; and

(b) No. W-7407 eng-6, dated 29 March 1943, with Baker and Company, Inc., Newark, N.J.

~~SECRET~~

(4) Purchase Orders.

The following important purchase orders were issued:

(a) No. 1, dated 9 October 1942, and Changes thereto, to S. D. Hicks Engineering Company, Inc., 1671 Hyde Park Avenue, Boston, Massachusetts, covering fabrication of five special fractionating towers.

(b) No. 42, dated 6 October 1942, and Changes thereto, to Artisan Metal Products, Inc., West Street and Sullivan Square, Charlestown, Massachusetts, covering fabrication of two special copper fractionating towers.

(c) No. 44, dated 3 November 1942, and Changes thereto, to Baker and Company, Inc., 113 Astor Street, Newark, N.J., covering manufacture of additional catalyst.

(5) Lease Arrangements.

The lease arrangements for the C M & S-owned facilities and for the land occupied by the U. S. Government-owned facilities are described in Section 3.

b. Description. (For Drawings, See App. D21).

(1) Site Plan.

The general arrangement of the plant and its relation to the existing plant of the C M & S Company are shown in Appendix A1.

(2) Buildings.

The new plant construction included the new buildings and extensions to existing buildings listed below, as indicated on the site plan and in the photographs in Appendix B1.

(a) Booster Building.

38' x 68' x 29' high; with "L" 10' x 36' x 29' high; concrete footings and floor, wood frame, 8" brick walls, tile interior partitions, laminated roofers and built-up roofing. This building contains booster hydrogen blowers.

(b) Primary Evaporator Building.

26' x 63' x 26' high; concrete footings and floor, wood frame, corrugated transite siding and roofing. This building contains water evaporating equipment.

(c) Primary Tower Structure.

28' x 66' x 124' high; reinforced concrete mat foundations, reinforced concrete frame construction. (Transite panelling was added later). This structure contains the following towers:

	<u>Number</u>	<u>Diam.</u>	<u>Approx. Ht.</u>
1st Stage	3	8'-6"	112'
2nd Stage	1	5'	108'
3rd Stage	1	2'-6"	98'
4th Stage	1	1'-6"	97'
Oxygen	1	6'	37'

(d) Secondary Concentration Plant.

39' x 131' x 22' high, with 9' x 11' x 22'

high additions; similar in construction to the Booster Building. This building contains water electrolyzing cells and auxilliary equipment.

(e) Cooling Tower.

25' x 61' x 35' high, concrete footings, wood construction. Capacity is 2400 g.p.m. (2000 Imperial) water from 105° F to 75° F at outdoor wet bulb temperature of 65° F.

(f) Pump House.

17' x 31' 14' high; similar in construction to the Primary Evaporator Building. This building contains two 2400 g.p.m. (2000 Imperial) pumps for cooling tower.

(g) Assay Laboratory.

25' x 34' x 12' high; one story addition to existing building; concrete footings and floor, wood frame, brick veneer exterior walls; built-up roofing, plaster-board interior partitions and ceiling. This building contains research and process control laboratory equipment.

(h) Oxygen Scrubber Tower.

Outdoor steel tower, occupying about 13' x 15' of ground, about 40' high.

~~SECRET~~

(i) Catalyst Shed.

32' x 35' x 20' high; similar in construction to Primary Evaporator Building. This building is used for catalyst screening and storage.

(j) Steam Boiler Plant.

42' x 64' x 47' high; addition to existing Canadian Government steam plant, conforming thereto in architectural treatment; concrete foundation, concrete and wood-grating floors, structural steel frame, transite siding, laminated roofers, built-up roofing. The boiler capacity is 60,000 lbs per hour at 190 lbs. per sq. in. pressure and 500° F, connected with existing mains.

(k) General.

In accordance with agreement between the CM&S Company and the U. S. Government, it was necessary that all the principal structures conform in general architectural treatment to the existing buildings in the Warfield Area. This provision applied particularly to the Booster Building, the Secondary Concentration Plant and the Assay Laboratory, which were accordingly constructed of more permanent materials, whereas the other buildings are for the most part of temporary construction as described above.

(3) Utilities.

(a) The existing water supply and sewer systems were used, with extensions and connections to the new plant.

~~SECRET~~

~~SECRET~~

(b) The existing electric power supply was likewise used, with the addition of a 1000 Kw. steam turbo-generator installed in the CM&S slag retreatment plant at Tadanac; this makes available an equivalent power capacity from existing sources for use in the heavy water plant.

(4) Fence.

An 8' wood picket-type fence was installed surrounding the principal U. S. Government facilities and the CM&S owned primary plant, in one inclosure.

e. Progress.

(1) Construction of the plant started 1 September 1942. Good progress was maintained, uniformly ahead of or on schedule. The Secondary Concentration Cell Plant was transferred to the operators 1 May 1943, the first stage towers of the Primary Concentration Plant were transferred to operation 16 June 1943, and the entire plant was completed 30 June 1943.

~~SECRET~~

(2) The following graph shows the progress at a glance:

% Complete

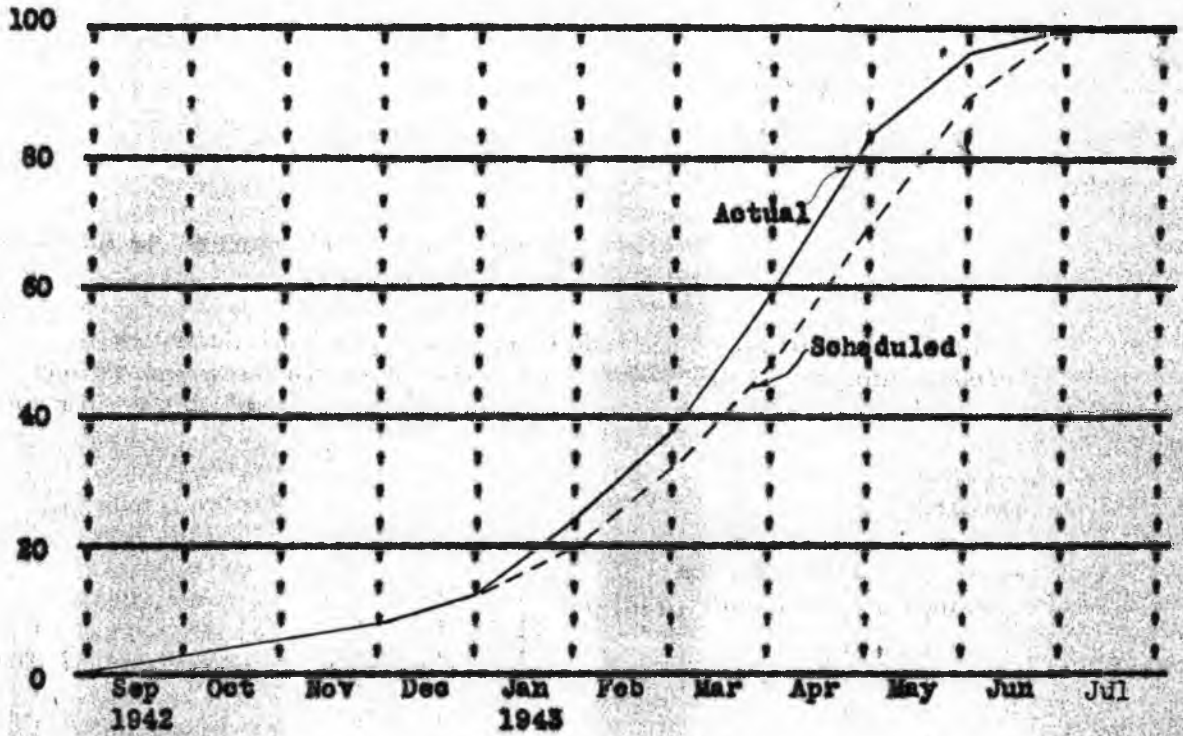

~~SECRET~~

d. Costs.

The following is a summary of the total cost, from War Department funds, of research and development, design and construction, as of 31 December 1946 (OSRD Expenditures, from War Department funds only, are included):

OSRD Expenditures from War Department funds	\$	204,198
New Buildings and Structures, and Extensions, including their Equipment		1,677,532
Alteration and Rearrangement of Existing Buildings and Equipment		212,793
Power and Process Lines		38,484
Purchase of Catalysts		465,797
Undistributed (Stone & Webster & C M & S Co.)		5,618
TOTAL COST	\$	<u>2,604,622</u>

These costs are also classified as follows:

OSRD Expenditures from War Department funds	\$	204,198
Design and Construction Costs:		
Stone & Webster Engineering Corp.		
Reimbursements	\$	916,453
Estimated Fixed Fee		<u>5,817</u>
		\$922,270
C.M.& S. Co.		
Reimbursements	\$1,076,038	
Fixed Fee		<u>1</u>
		\$1,076,039
Items Furnished by Government*		124,873 \$2,123,182
Additional Purchase of Spare Catalysts		<u>277,242</u>
TOTAL COST		<u>\$2,604,622</u>

* Includes Government overhead

~~SECRET~~

4-2. Plant at Morgantown Ordnance Works. (App. D16).

a. Contracts.

(1) Prime Contract.

The Ordnance Department's Supplemental Agreement No. 7 to cost-plus-a-fixed-fee Contract No. W-ORD-490, with E. I. du Pont de Nemours & Company, Inc., Wilmington, Delaware, previously referred to in Section 3, covered the construction of the plant for production of heavy water at the Morgantown Ordnance Works, Morgantown, West Virginia.

(2) Subcontracts.

All portions of the work which could be most advantageously performed by others were subcontracted.

b. Description. (For Drawings, see App. D22).

(1) Site Plan.

The general arrangement of the plant and its relation to the existing plant of the Morgantown Ordnance Works are shown in Appendix A2.

(2) Buildings.

The new plant construction included the buildings and structures listed below, as indicated on the site plan and in the photographs in Appendix B2.

(a) Process Pump and Control Building (Bldg. #178)

95' x 22' x 16' to eaves; concrete foundation and floor, wood frame, corrugated asbestos walls and roof. This building includes the following:

(1) Distillation Towers:

<u>Stage</u>	<u>Number</u>	<u>Diameter</u>	<u>Approx. Height</u>	<u>Description</u>
1st	5	15'	100'	80 Plate Steel Tunnel Cap
	5	12'	106'	90 Plate Steel Bubble Cap
2nd	1	10'-6"	84'	72 Plate "
	1	8'	93'	83 Plate "
3rd	1	3'-4"	77'	72 Plate "
4th	1	18"	77'	Packed Steel Col. 72' high
5th thru 8th	4	10"	77'	"

(2) Other Equipment: calandrias, evaporators, condensers, pumps, coolers, tanks, separators, air compressor, ammonia compressors.

(b) Finishing (Electrolytic) Building (Bldg. #179)

94' x 26' overall with area 66' x 26' x one story, 22' to eaves; one bay 14' x 26' x 3 stories, 47' to eaves; and one bay 14' x 26' x 2 stories, 30' to eaves; concrete foundations; concrete and wood floors; wood frame; corrugated asbestos siding; built up roofing on wood deck over one story portion and corrugated asbestos roofing over remainder; 12" brick firewall. This building contains: 64 - 1000 Amp. Electrolytic Cells, tanks, pumps, burners, condenser, rectifier and associated switchgear.

(c) Change House, Office and Laboratory Building (Bldg. #413).

"L" shape, with wings 106' x 37' x 14' to eaves and 62' x 37' x 14' to eaves; concrete foundation, wood and composition floors, wood frame, wood siding, built-up roof; except laboratory room, 34' x 37', which has concrete floor and masonry walls. This building contains temperature and humidity

control apparatus (in the laboratory); also, a fire resistant vault, laboratory equipment, office equipment, showers, etc.

(d) Product Storage Building (Bldg. #180).

19' x 41' x 11' high; concrete foundations and floors, cinder block walls, concrete and built-up roof.

(e) Cooling Tower (Bldg. #203).

16 cell induced draft type, redwood construction; 289' x 29' x 30' high; pump pit: 148' x 30', 7 pumps; capacity is 28,000 g.p.m. water from 100° F. to 86° F.

(f) Low Pressure Boiler House (Bldg. #241).

62' x 46' x 38' high; concrete foundation, concrete and steel-grating floors and platforms, structural steel frame, corrugated asbestos siding and roof. This building contains: integral-furnace, gas-fired boilers and accessories, capacity 160,000# steam per hour at 150 p.s.i. pressure; forced draft fans; flash tank; treating and storage tank; steam driven air compressor; steam turbines.

(3) Additional Facilities.

(a) The following additional equipment was installed in existing buildings:

(1) In the existing Power House (Bldg. #201): coal pulverizers and coal valves, on existing boilers.

(2) In the existing Filter Plant (Bldg. #230): a 21' x 56' x 16' deep subsidence basin with steel frame housing addition, well, filter unit and softener, with all accessories and piping.

(b) Additional steam is supplied to the heavy water plant from the existing main plant boiler house, through reduction equipment. An average of from 45,000 to 50,000 pounds of steam has been purchased monthly from the main plant system.

(4) Utilities.

(a) The existing water supply system has been used, with new connections, and with the additions to the existing water filter plant to accommodate the heavy water plant requirements, as described above.

(b) The existing sewer system and electric power supply have been used, with connections to the new plant.

(c) All the buildings are heated by steam from the new boiler house.

c. Progress.

(1) Construction of the plant started 7 January 1943, substantially all scheduled work was completed in advance of the originally estimated completion date, 1 September 1943, and the project (except for changes during operation) was fully completed on 31 December 1943.

(2) Units of the plant were placed in initial operation as soon as installations were completed, on the following dates:

Process Equipment - Stage 2	29 May 1945
Process Equipment - Miscellaneous	4 June
Filtered Water Plant	9 June
Utilities and Accessory Construction	9 June
Power Plant	29 June
Process Equipment - Stage 1	29 June
Process Equipment - Stages 3 - 8	21 July
Buildings	28 August

(5) The following graph shows the progress of the entire job, at a glance:

% Complete

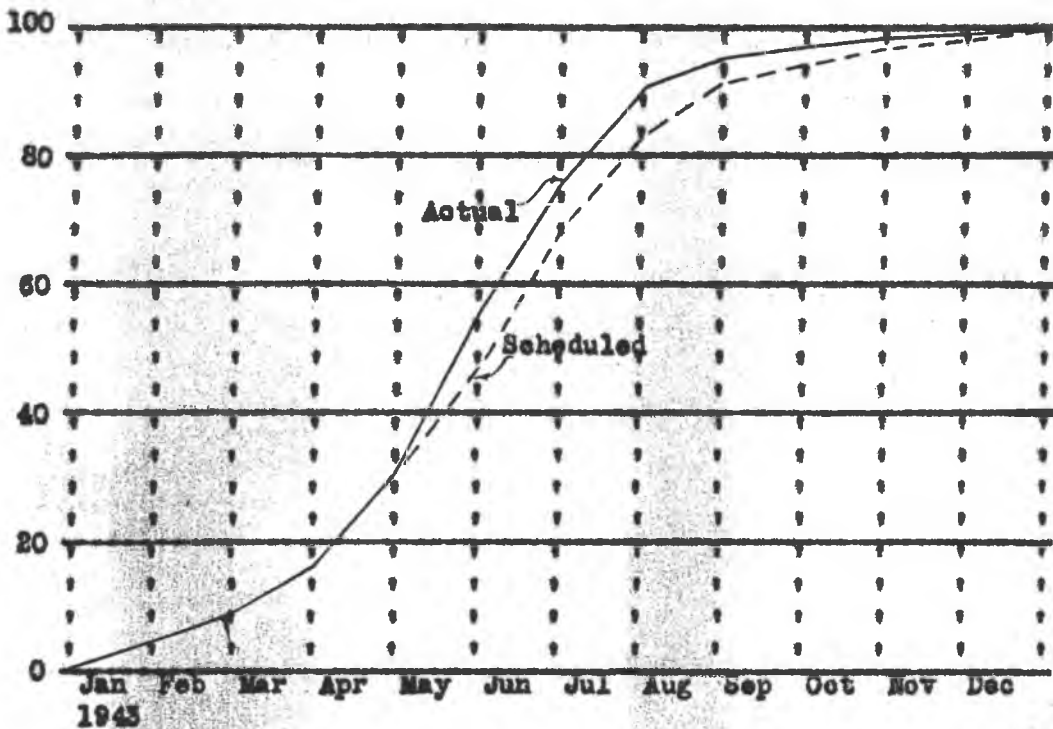

~~SECRET~~

d. Costs.

The following is a summary of the total cost, as of 31 December 1945.

Major Process Equipment and Bldgs.	\$	1,993,866
Power Plant		868,418
Other Buildings (and their Equipment)		367,251
Utilities and Accessory Construction		255,670
NET CONSTRUCTION COST	\$	<u>3,475,205</u>
Offset Accounts (Debits minus Credits)		14,864
AMOUNT CHARGEABLE TO MANHATTAN DISTRICT FUNDS	\$	<u>3,490,069</u>

These costs are also classified as follows:

Payments to Contractor:			
Contractor's Reimbursements	\$2,724,058		
Contractor's Procurements	475,744		
Contractor's Fixed Fee	<u>88,588</u>	Total	\$3,288,590
Items Furnished by Government*			272,622
Transfers of Surplus Material and Equipment from Construction, Credit			- 85,807
NET CONSTRUCTION COST **			<u>\$3,475,205</u>
Offset Accounts (Debits minus credits)			14,864
AMOUNT CHARGEABLE TO MANHATTAN DISTRICT FUNDS			<u>\$3,490,069</u>

* Includes Government overhead.

** Costs incurred under OSRD Contracts are not included.

Under the original contract the prime contractor's fixed fee amounted to \$154,882, but this was voluntarily reduced to \$88,588 when the Contractor found that the cost of construction was appreciably less than that originally estimated, as noted below, and the contract was modified accordingly by supplemental agreement dated 22 June 1944.

The estimated cost of construction, as stated in the contract, was \$6,054,000, and this did not include the fixed fee

~~SECRET~~

nor the costs of additions to the contract. The actual costs therefore were materially less than those originally anticipated.

4-3. Plant at Wabash River Ordnance Works. (App. D17).

a. Contracts.

(1) Prime Contract.

The Ordnance Department's Supplemental Agreement No. 6 to cost-plus-a-fixed-fee Contract No. W-ORD-556, DA-W-ORD-38, with E. I. du Pont de Nemours & Company, Inc., Wilmington, Delaware, covered the construction of the plant for production of heavy water at the Wabash River Ordnance Works, Montezuma (or Newport), Indiana.

(2) Subcontracts.

All portions of the work which could be most advantageously performed by others were subcontracted.

b. Description. (For Drawings, see App. D23).

(1) Site Plan.

The general arrangement of the plant and its relation to the existing plant of the Wabash River Ordnance Works are shown in Appendix A3.

(2) Buildings.

The new plant construction included the buildings and structures listed below, as indicated on the site plan and in the photographs in Appendix B3.

(a) Process Pump and Control Building (Bldg. #3178)

291' x 22' x 26' to eaves; concrete foundations and floor, wood frame, corrugated asbestos walls and roof; concrete

floor, wood frame, asbestos covered sheet iron siding and roof.

This building includes the following:

(1) Distillation Towers.

<u>Stage</u>	<u>Number</u>	<u>Diameter</u>	<u>Approx. Height</u>	<u>Description</u>
1st	15	15'	100'	80 Plate Steel Tunnel Cap
	15	12'	106'	90 Plate Steel Bubble Cap
2nd	3	10'-6"	84'	72 Plate "
	3	8'	93'	83 Plate "
3rd	1	5'-6"	77'	72 Plate "
4th	1	2'-6"	77'	72 Plate "
5th thru 8th	4	18"	77'	Packed Steel Col. 72" high

(2) Other Equipment: Calandrias, evaporators, condensers, pumps, coolers, tanks, receiver, separators, air compressor, ammonia compressors.

(b) Change House, Office and Laboratory Building (Bldg. #3415).

"L" shape, with wings 106' x 37' x 14' to eaves and 62' x 37' x 14' to eaves; concrete foundation, wood and composition floors, wood frame, wood siding, composition roof; except laboratory room, 34' x 37', which has concrete floor and masonry walls. This building contains temperature and humidity control apparatus (in the laboratory); also, a fire resistant vault, laboratory equipment, office equipment, showers, etc.

(c) Product Storage Building (Bldg. #3180).

19' x 41' x 11' high; concrete foundations and floors, brick walls, concrete and built-up roof.

(d) Heavy Water Plant Area Gate and Guard House (Bldg. #3181).

12' x 32' x 11 $\frac{1}{2}$ ' high; wood foundation, floors and siding; composition roofing.

(e) Warehouse or Shop (Bldg. #3722).

Approx. 25' x 30' x 11 $\frac{1}{2}$ ' high; concrete and wood floors, wood frame, composition siding and roofing.

(f) Power House Addition (Bldg. #401).

117' x 94' x 86' high, extension to existing boiler room; also, 46' x 49' x 27' high extension to existing softener and filter room; concrete foundations, structural steel frame, transite siding and roof. The foundations were adapted from work previously installed in connection with another project which was abandoned. This building contains: Boilers, 570,000# capacity, 600 p.s.i. pressure, with auxiliaries; motors, fans, turbines, de-aerating heater, coal scales, pumps, water softeners.

(g) Wells and Pumps (Bldg. #404).

The equipment installed in the water supply area includes three Ranney water collectors, deepwell turbine pumps, air compressor and air receiver tanks. Part of the caisson work on the wells was adapted from work previously installed in connection with another project which was abandoned.

(h) Pump House (Reservoir) Addition (Bldg. #412).

18' x 72'; this addition contains centrifugal pumps and motors.

(3) Utilities.

(a) The existing water supply system has been used, with connections and the additional wells and equipment described above, to accommodate the heavy water plant requirements.

(b) The existing sewer system and electric power supply have been used, with connections to the new plant.

(c) The buildings are heated by steam from the power house addition.

(d) About 1/2 mile of railroad track and an access road to the process area were installed.

e. Progress.

(1) Construction of the plant started 23 January 1943; it was substantially completed on 22 October 1943 and fully completed on 13 December 1943.

(2) Various plant units were transferred to the Operating Department as they were ready for use; initial operation of the P-9 manufacturing units took place on 17 June and all stages of the plant were ready for full operation 18 September 1943.

(3) The following graph shows the progress of the entire job, at a glance:

~~SECRET~~

% Complete

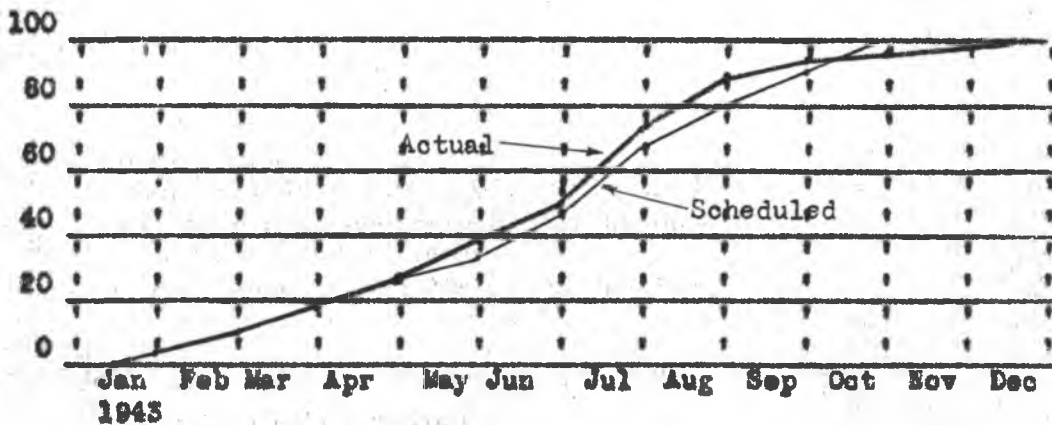

d. Costs.

The following is a summary of the total cost, as of 31 December 1946.

Major Process Equipment and Bldgs.	\$3,919,228
Power Plants	2,010,560
Other Buildings (and their Equipment)	270,565
Utilities and Accessory Construction	1,885,778
NET CONSTRUCTION COST	\$7,885,929
Offset Accounts (Credits minus Debits) CR	- 392,762
AMOUNT CHARGEABLE TO MANHATTAN DISTRICT FUNDS	\$7,493,167

These costs are classified as follows:

Payments to Contractor:		
Contractor's Reimbursements	\$6,816,753	
Contractor's Fixed Fee	<u>152,472</u>	\$6,969,205
Items furnished by Government*		1,156,412
Transfers of Surplus Material and Equipment from Construction, Credit		- 239,688
NET CONSTRUCTION COST **		\$7,885,929
Offset Accounts (Credits minus Debits) CR		- 392,762
AMOUNT CHARGEABLE TO MANHATTAN DISTRICT FUNDS		\$7,493,167

* Includes Government overhead.

** Costs incurred under OSRD Contracts are not included.

~~SECRET~~

Under the original contract the prime contractor's fixed fee amounted to \$272,776, but this was voluntarily reduced to \$152,472 when the contractor found that the cost of construction was appreciably less than that originally estimated, as noted below, and the contract was modified accordingly by supplemental agreement dated 22 June 1944.

The estimated cost of construction, as stated in the contract, was \$13,865,000, and this did not include the fixed fee, nor the costs of additions to the contract. The actual costs therefore were materially less than those originally anticipated.

4-4. Plant at Alabama Ordnance Works. (App. D18).

a. Contracts.

(1) Prime Contract.

The Ordnance Department Supplemental Agreement No. 15 to cost-plus-a-fixed-fee Contract No. W-ORD-526, DA-W-ORD-1, with E. I. du Pont de Nemours & Co., Wilmington, Delaware, covered the construction of the plant for production of heavy water at the Alabama Ordnance Works, Sylacauga (or Childersburg), Alabama.

(2) Subcontracts.

All portions of the work which could be most advantageously performed by others were subcontracted.

b. Description. (For Drawings, See App. D24).

(1) Site Plan.

The general arrangement of the plant and its relation to the existing plant of the Alabama Ordnance Works are shown in Appendix A4.

(2) Buildings.

The new plant construction included the buildings and structures listed below, as indicated on the site plan and in the photographs in Appendix B4.

(a) Process Pump and Control Buildings (Bldg. #2178).

195' x 22' x 16' to eaves; concrete foundation and floor, wood frame, corrugated asbestos walls and roof. This building contains the following:

(1) Distillation Towers.

<u>Stage</u>	<u>Number</u>	<u>Diameter</u>	<u>Approx. Height</u>	<u>Description</u>
1st	10	15'	100'	80 Plate Steel Tunnel Cap
	10	12'	106'	90 Plate Steel Bubble Cap
2nd	2	10'-6"	84'	72 Plate "
	2	8'	93'	83 Plate "
3rd	1	4'-6"	77'	72 Plate "
4th	1	2'	77'	72 Plate "
5th thru 8th	4	16"	77'	Packed Steel Col. 72' high

(2) Other Equipment: Calandrias, evaporators, condensers, pumps, coolers, tanks, ammonia receiver, air compressor, separators.

(b) Change House, Office and Laboratory Building (Bldg. #2415).

"I." shape, with wings 106' x 37' x 14' to eaves and 62' x 37' x 14' to eaves; concrete foundations, wood and composition floors, wood frame, wood siding, composition roof, except laboratory room, 34' x 37', which has concrete floor and masonry walls. This building contains temperature and humidity control

apparatus (in the laboratory); also, a fire resistant vault, laboratory equipment, office equipment, showers, etc.

(c) Product Storage Building (Bldg. #2130).

19' x 41' x 11' high; concrete foundations and floors, brick walls, concrete and built-up roof.

(d) Heavy Water Plant Area Gate and Guard House (Bldg. #2181).

Approx. 20' x 10' x 10' high; wood foundation, floor and frame; corrugated metal walls and roof.

(e) Warehouse or Shop (Bldg. #2722).

Approx. 45' x 65' x 12' high; wood foundations, floor and frame, corrugated metal walls and roof.

(3) Additional Facilities.

The following additional equipment was installed in existing buildings:

(a) In the existing Power House (Bldg. #4018): steam regulating system and control, de-superheater pumps and controls, de-aerator, water softener, boiler feed pump.

(b) In the Pump House (Bldg. #2220): additional pumps.

(4) Utilities.

(a) The existing water supply system, electric power supply and steam supply have been used, with connections to the new plant.

(b) A septic tank was installed for the sewer system.

c. Progress.

(1) Construction of the plant started on 11 February 1943 and was completed on 15 November 1943. (This is exclusive of De-Superheater Station revisions, which are not considered a part of the original construction).

(2) Various plant units were transferred to the Operating Department as they were ready for use; initial operation of the first processing unit took place on 29 May 1943 and the last unit was started on 4 September 1943.

(3) The following graph shows the progress of the entire job, at a glance:

% Complete

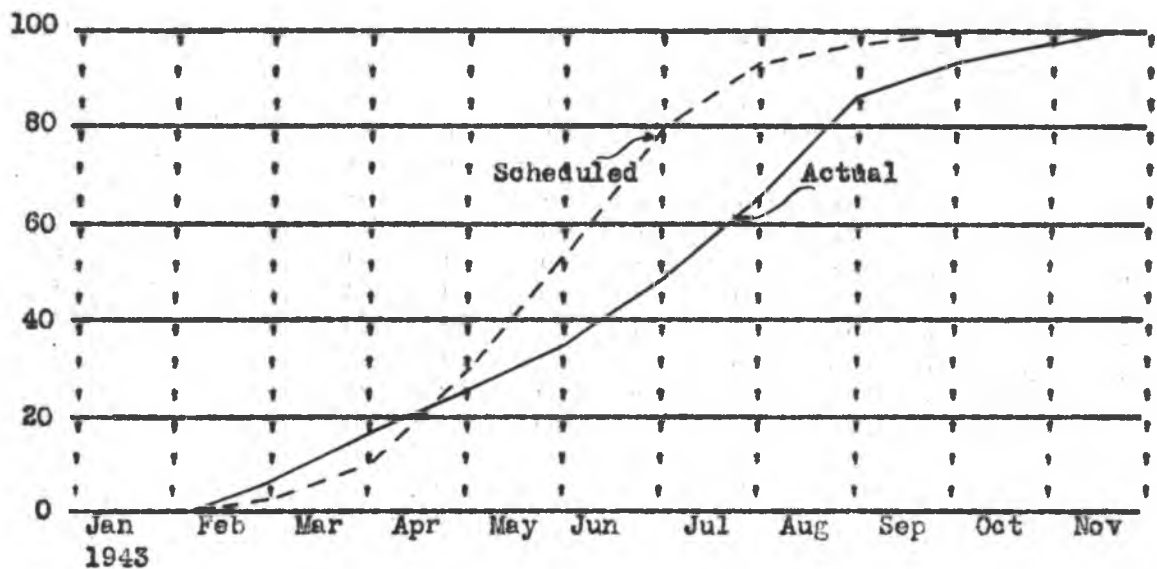

~~SECRET~~

d. Costs.

The following is a summary of the total cost, as of 31 December 1946.

Major Process Equipment and Bldgs.	\$2,382,095
Power Plant (Equipment)	135,409
Other Buildings (and their Equipment)	250,771
Utilities and Accessory Construction	558,652
NET CONSTRUCTION COST	<u>\$3,319,927</u>
Offset Accounts (Debits Minus Credits)	146,244
AMOUNT CHARGEABLE TO MANHATTAN DISTRICT FUNDS	<u>\$3,466,171</u>

These costs are also classified as follows:

Payments to Contractor		
Contractor's reimbursements	\$2,577,156	
Contractor's Procurements	837,661	
Contractor's fixed Fee	<u>70,368</u>	
		\$3,285,185
Items Furnished by Government:		253,667
Transfers of Surplus Material and Equipment from Construction, Credit		- 218,925
NET CONSTRUCTION COST**		<u>\$3,319,927</u>
Offset Accounts (Debits Minus Credits)		146,244
AMOUNT CHARGEABLE TO MANHATTAN DISTRICT FUNDS		<u>\$3,466,171</u>

* Includes Government overhead

** Costs incurred under OSRD Contracts are not included.

Under the original contract the prime contractor's fixed fee amounted to \$184,680, but this was voluntarily reduced to \$70,368 when the Contractor found that the cost of construction was appreciably less than that originally estimated, as noted below, and the contract was modified accordingly by supplemental agreement dated 22 June 1944.

The estimated cost of construction, as stated in the contract, was \$8,285,000, and this did not include the fixed fee nor the costs of additions to the contract. The actual costs therefore were materially less than those originally anticipated.

~~SECRET~~

4-5. Recapitulation of Costs.

a. The total costs of the four plants for the production of heavy water (as of 31 December 1946) may be listed as follows:

(1) Trail Plant (including OSRD Expenditures from War Department funds).		\$2,604,622
(2) Plants in the United States:		
(a) Morgantown Ord. Wks.	\$ 3,475,206	
(b) Wabash River Ord. Wks.	7,885,929	
(c) Alabama Ord. Wks.	5,519,927	
(d) OSRD Expenditures from War Department funds (Not distributed)	<u>62,150</u>	
		<u>\$14,745,211</u>
TOTAL		\$17,347,833

b. The estimates of cost as stated in the Contracts indicated that the combined cost of the three plants in the United States might be \$27,854,000 (App. D25, D26). The reduction in cost to \$14,681,061 (excluding OSRD Expenditures from War Department Funds) therefore represents an apparent saving of nearly 50%. The extreme conservatism of the original estimates, doubtless dictated by the novelty of the proposed plants, was primarily responsible for this large reduction.

The following factors which could not be fully anticipated beforehand also contributed materially to the lower costs:

~~SECRET~~

(1) The similarity of the three plants involved numerous repetitions of identical and similar items and mass production of materials and production line methods of installation therefore permitted large savings in costs of materials and construction labor.

(2) Construction organizations, with building equipment and tools were already present at the sites selected, because of the Ordnance projects at these sites; this permitted reductions to be made in the anticipated costs of both the supervision and the construction. (App. D27).

~~SECRET~~

~~SECRET~~

SECTION 5 - OPERATION

5-1. Plant at Trail, B. C.

a. Contracts.

(1) Operation of the heavy water plant at Trail, B. C., was covered by Contract No. E-7405-eng-11, dated 31 July 1942, with the Consolidated Mining & Smelting Company, as operator (as well as construction contractor, see Section 4), approved by the Under Secretary of War.

Important provisions of this basic contract were:

(a) Consolidated Mining and Smelting Company's obligation to produce heavy water was subject to concurrent operation of their electrolytic ammonia producing plant; it was also dependent upon power and their normal product disposal conditions. Under the latter conditions the U. S. had the right to require CMAS to operate their ammonia plant (so that the heavy water plant could be operated) subject to reasonable agreed compensation.

(b) The Consolidated Mining and Smelting Company was obligated to operate the heavy water plant on a no profit, no loss, basis and receive other considerations as described in the arrangements outlined below.

(c) Periods of operation were arranged as follows:

(1) Period One - CMAS was to operate the heavy water plant to date of cessation of hostilities between the U. S. and the Axis Powers, or until 1 January 1946, whichever was later. The U. S. had the right to the entire output of the F-9 plant during this period. CMAS had the right to the portion not required by the U. S., at a pro-

~~SECRET~~

portionate cost.

(2) Standby Period. - Immediately following the first period of operation CMAS was to maintain the plant in standby condition for two years and had the right to operate the plant and take the entire output less such reasonable quantities as the U. S. might require for incidental purposes.

(3) Second Period of Operation. - During the standby period the U. S. could inform CMAS by 90 days notice that the U. S. would require the output of heavy water for a period beginning at any time before expiration of 90 days immediately following the standby period and ending at any time before the last day of a period of three years next following the standby period. During this period CMAS might take 60% of the heavy water output and such other quantities as were not required by the Government. In the event that the U. S. becomes involved in hostilities with a country other than a member of the British Empire, during the standby period or second period of operation, and required heavy water for war purposes, the U. S. had the right of priority to purchase that part of the heavy water output to which CMAS was entitled during the second period of operation.

(4) Lease Period. - For a period of 21 years after termination of the standby period or the second period of operation, CMAS might take possession of the heavy water plant on lease, at an annual rental of 1% of the proceeds of the sale of heavy water for each year. During this lease period CMAS had the exclusive right to purchase the plant at the then estimated cost of replacement, less depreciation from the installation date to the date of commencement of the lease period,

~~SECRET~~

or (at CMAS election) for an amount equivalent to the highest bona fide bid to the U. S. for sale and removal of the plant. CMAS might terminate the lease by 90 days notice. If, during the lease period, the U. S. becomes involved in hostilities with a country other than a member of the British Empire, the U. S. had priority to purchase the entire plant output at maximum capacity; at all other times during the lease period the U. S. had priority to purchase up to 50% of the output currently available.

(5) Right of Purchase. - If CMAS did not purchase the plant, and the lease period expired or was terminated, the U. S. should within six months thereafter, dismantle and remove the plant and restore the CMAS premises to the condition existing before the plant was installed.

(6) Operation of the addition to the Canadian Government steam plant was covered by Contract No. W-7418-eng-70, dated 9 December 1943, to take effect as of 12 January 1943, with modification dated 22 March 1944, between the Canadian Government and the U. S. Government, with CMAS Company as intervenant.

As pointed out above, the original C M & S Contract (cost reimbursement) provided for the Contractor's privilege to use all production during the standby period (less such reasonable quantities as the United States might require for incidental purposes) and 50% of the production in the second period of operation. Since the Government desired to retain control of all material during these periods, it was necessary to devise a modification, Modification No. 1, to the contract, effective 1 September 1946 in which the Contractor agreed to turn over

~~SECRET~~

~~SECRET~~

A complete production to the Government on a unit price basis. This unit price was established such that the Government paid the Contractor's price of \$78.72 per pound for the entire production in the 90-day standby period following 1 September, 1946; and \$53.44 per pound for entire production during the second period of operation. The price for the second period of operation was arrived at by averaging 50% of production at the Contractor's price; viz., \$78.72, and 50% at cost-plus-overhead; viz., approximately \$28 per pound. By 31 December, 1946 a second supplement, Modification No. 2, was being prepared in order to have the Contractor provide certain additional services other than the production of P-9. These services were to be provided at cost and were to include processing of certain O18-enriched stocks to produce O18-enriched water, reconcentrating certain diluted P-9 stocks to product specifications, etc.

b. History of Operation. (App. D28, D29, D30, D31, D32)

(1) Start-up - The Secondary Concentration Cell plant was transferred to the operators on 1 May 1943. The first stage towers of the Primary Concentration plant were started on 16 June 1943. By July 1943 all essential portions of the plant were in operation. Because of the nature of the process, however, considerable time was required for the material in the plant to reach and maintain equilibrium to the point where quantities of heavy water of required concentration could be drawn off.

~~SECRET~~

~~SECRET~~

(2) Production.

(a) The initial design of the F-S plant at Trail was based upon a proposed heavy water production rate of 0.5 tons (1000 pounds) per month. After the equipment became available for operation, estimates of anticipated production were made and these were progressively revised from time to time, as shown in the tabulation which follows. The original estimate and the actual production figures have been inserted for comparison.

~~SECRET~~

~~SECRET~~

PRODUCTION ESTIMATES

Month	Original	5 May		11 Oct		30 Mar		Act. Prod.
		1943	1943	1943	1944	1944	1944	
June 1943	1000	80	50					15
July	1000	275	150					31
Aug.	1000	600	250					27
Sept.	1000	950	350					51
Oct.	1000	1100	450	50				137
Nov.	1000	1200	550	150				125
Dec.	1000	1200	650	250				275
Jan. 1944	1000	1200	750	350	400			326
Feb.	1000	1200	850	450	500			513
Mar.	1000	1200	950	550	600	462		457
Apr.	1000	1200	1050	650	700	500		490
May	1000	1200	1150	750	800	700		701
June	1000	1200	1200	850	900	800		726
July	1000	1200	1200	950	1000	900		804
Aug.	1000	1200	1200	1050	1000	1000		650
Sept.	1000	1200	1200	1150	1000	1000		824
Oct.	1000	1200	1200	1200	1000	1000		905
Nov.	1000	1200	1200	1200	1000	1000		955
Dec.	1000	1200	1200	1200	1000	1000		1050
Jan. 1945	1000	1200	1200	1200	1000	1000		1055
Feb.	1000	1200	1200	1200	1000	1000		910
Mar.	1000	1200	1200	1200	1000	1000		973
Apr.	1000	1200	1200	1200	1000	1000		1085
May	1000	1200	1200	1200	1000	1000		1100
June	1000	1200	1200	1200	1000	1000		1006
July	1000	1200	1200	1200	1000	1000		985
Aug.	1000	1200	1200	1200	1000	1000		1106
Sept.	1000	1200	1200	1200	1000	1000		1060
Oct.	1000	1200	1200	1200	1000	1000		1105
Nov.	1000	1200	1200	1200	1000	1000		1095
Dec.	1000	1200	1200	1200	1000	1000		1100-540*
Jan. 1946	1000	1200	1200	1200	1000	1000		950-345*
Feb.	1000	1200	1200	1200	1000	1000		825-570*
Mar.	1000	1200	1200	1200	1000	1000		1175-131*
Apr.	1000	1200	1200	1200	1000	1000		1155
May	1000	1200	1200	1200	1000	1000		1170
June	1000	1200	1200	1200	1000	1000		1028
July	1000	1200	1200	1200	1000	1000		1056
Aug.	1000	1200	1200	1200	1000	1000		1305
Sept.	1000	1200	1200	1200	1000	1000		1132
Oct.	1000	1200	1200	1200	1000	1000		1080
Nov.	1000	1200	1200	1200	1000	1000		1330
Dec.	1000	1200	1200	1200	1000	1000		852

*Represents increased production due to introduction of duFont holdup material into Trail Operations.

(To make the comparison complete, the estimated figure for maximum production has in each case been repeated from month to month.)

5.5.1

~~SECRET~~

(b) The actual production each month, in terms of percentages of the quantities originally estimated, is shown on the following graph:

% Of Original Estimate

Represents increased production due to introduction of du Pont holdup material into Trail Operation.

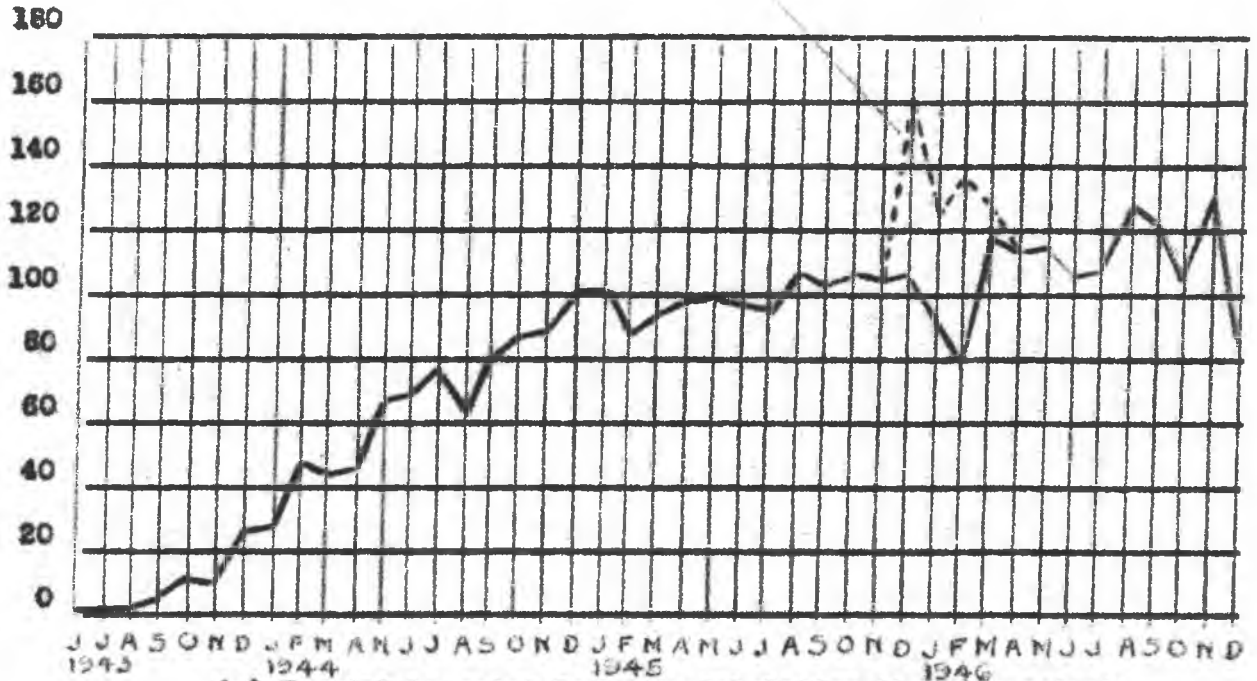

(c) It will be noted from the tabulation that the actual production figures have gradually and almost continuously increased, while the estimates have been revised progressively downward, with the result that the actual and the latest estimated figures reached general agreement at the end of the year 1944. The low actual production prior to that time is primarily attributable to the delay, referred to previously, in attaining the desired concentration equilibrium. Despite this delay, however, the design rate has been attained each month, with very few exceptions, since December 1944.

(d) Factors contributing to the delay in production may be classified as minor and major. The minor factors prevailed for the most part during the early production period; they comprised, briefly:

(1) Electrical power surges and minor failures which interrupted the operating cycle.

(2) Various modifications and changes in equipment or auxiliary systems, such as: changes in the hydrogen piping; changes in the burner arrangement; installation of nitrogen pump lines; re-arrangement of the secondary plant equipment.

(e) The major factors were:

(1) An abnormally dry season, which produced a scarcity of hydro-electric power for the electrolytic cells throughout a period from late January to early April, 1944. This reduced hydrogen production to 67% of the maximum. It is believed that revisions which have been made since that time to the dam at the site of the power station will now assure an adequate power supply at all seasons.

(2) Loss of deuterium in various stages of concentration. This factor caused grave concern. A loss reduction program was initiated and concerted efforts were made by the operators, the consultants and the Manhattan District to eliminate leakage wherever practicable. This program led to the adoption of: an adequate overflow collection system; an alarm system to give warning of unsuitable gas pressure in the cells; and vapor-tight cell covers. The success of these corrective measures is evidenced by the increased monthly production records.

(f) Two additional methods of increasing production

~~SECRET~~

were suggested and considered:

Proposal 1. To add 49 electrolytic cells to the primary plant. This was proposed in July 1944 by GM&S and it was estimated that it would cost \$30,000, increase production 16 lbs. per month, and require about 5 months to install the cells and attain equilibrium. After careful study the Manhattan District disapproved this proposal because the small additional amount of product would not justify the additional expenditure. It was estimated that the additional quantity to be accumulated in a period of 18 months (at 16 lbs. per month for 13 months, 208 lbs. total) could be obtained by operation of the Trail plant, without the additional cells, for only about 9 additional days at a cost of approximately \$9,000; and that the additional quantity to be accumulated in a period of two years could be obtained by operation for only about 12 additional days at a cost of approximately \$12,000. (App. D33).

Proposal 2. To add a distillation tower and make use of about 40,000 to 50,000 lbs. of excess steam, made available by GM&S Company through reduction of some of their independent processes. This proposal was made in August 1944 by GM&S Company, and it was roughly estimated that it would increase the output of the plant about 5%, at a monthly increase in operating cost of about \$19,000. After a careful review had been made of overall needs and anticipated availability of heavy water in the future, this proposal was dropped, because of probable high cost and because it was not desirable to introduce a different process, with which the operating force was totally unfamiliar.

c. Production Records. (App. D34). - The following tabulation shows the monthly record of production from the startup of operation of the

~~SECRET~~

heavy water plant at Trail:

<u>Month</u>	<u>Production in Lbs.</u>	<u>Month</u>	<u>Production in Lbs.</u>
June, 1943	15	April, 1945	1095
July	31	May	1100
August	27	June	1005
September	61	July	985
October	137	August	1105
November	125	September	1060
December	276 - 67'	October	1105
January, 1944	326	November	1095
February	515	December	1100 + 540*
March	467	January, 1946	950 + 343*
April	490	February	825 + 570*
May	701	March	1175 + 131*
June	726	April	1155
July	804	May	1170
August	650	June	1025
September	824	July	1056
October	905	August	1306
November	955	September	1132
December	1050 - 24''	October	1080
January, 1945	1055	November	1330
February	910	December	862
March	978		

*Represents increased production due to introduction of duPont holdup material into Trail Operations. After March 1946 this material was reported cumulatively by the contractor.

The total cumulative production to the end of December, 1946 was 36,311 pounds.

d. Production Costs.

(1) Operating Costs. (App. D35) - The cost of operation of the heavy water plant at Trail was originally estimated at about \$800 per day or \$24,000 per month. Actual operating costs per month and per pound produced during the months have been as follows:

~~SECRET~~

<u>Month</u>	<u>Operating Cost</u>	<u>Production in Lbs.</u>	<u>Operating Cost per Lb.</u>
June, 1943	\$ 21,379	15	\$1425
July	30,630	51	988
August	27,271	27	1010
September	25,679	61	421
October	27,087	157	198
November	35,512	125	269
December	28,289	275	103
January, 1944	30,607	326	94
February	41,708	513	81
March	35,366	467	71
April	27,408	490	58
May	26,233	701	37
June	24,678	726	34
July	26,089	804	32
August	25,456	650	39
September	25,399	824	32
October	26,079	905	29
November	27,741	955	29
December	27,504	1050	26
January, 1945	29,095	1055	28
February	24,401	910	27
March	28,862	973	30
April	28,200	1095	26
May	29,083	1100	26
June	25,868	1005	26
July	29,840	985	30
August	30,019	1105	27
September	28,767	1050	27
October	29,291	1105	27
November	28,543	1095	26
December	28,055	1100	25
January, 1946	25,550	950	27
February	21,802	828	26
March	27,139	1175	23
April	26,337	1165	23
May	27,552	1170	24
June	27,810	1025	27
July	30,938	1056	29
August	30,718	1305	24
September	89,111	1182	78.72**
October	85,017	1080	78.72**
November	104,697	1330	78.72**
December	45,530	852	53.44***

Ave. 43 Mos.

June 43 - Dec. 46 \$32,979

845 lbs.

\$39.00

*Represents increased production due to introduction of duPont hold-up material into Trail Operation. Here treated as if it was Trail Production in its entirety.

**Unit price for 90-day standby period (Modification No. 1 to GM&S Contract).

***Unit price for second period of operation (Mod. No. 1 to GM&S Contract).

~~SECRET~~

(2) Total Cost per Pound of Product. If the capital investment (\$2,604,622) is amortized on the basis of 120 months plant life and this amortisation added to the cost of operation from the start up of operations to 1 September 1946 (Beginning of standby period as defined by Modification No. 1), the overall cost per pound of the heavy water may be calculated as follows:

To September 1, 1946

Amortisation:	
3/10 x \$2,604,622	\$ 782,000
Total Operating Cost	1,093,765
Total Cost	<u>\$1,876,765</u>
Total Production	31,217
Total Cost per Pound	<u>59.82</u> lbs.

Immediately following 1 September 1946, for the 90-day standby period, the unit price per pound of P-9 was \$78.72. For the second period of operation following December 1, 1946 the unit price per pound of P-9 is \$53.44. (These unit prices are in accordance with Modification No. 1 to G M & S Contract)

5-2. Plants in the United States.

a. Contracts. Operation of the three heavy water plants in the United States is covered by the same Ordnance Department contracts with E. I. duPont de Nemours and Company, which provided for construction. (See Section 4) Important provisions of these contracts are:

(1) Morgantown Ordnance Works. - Title III, Supplemental Agreement No. 7 to Contract No. W-ORD-490.

Estimated monthly operating cost \$72,400
Estimated monthly production 800 lbs. (12,800 "Units")
Operating fee \$6.08 per lb. for first 800 lbs. per month; \$3.20 per lb. for each additional lb. per month (\$0.38 and \$0.20

~~SECRET~~

per "unit" respectively).

Minimum fee, \$2,400 per month.

(2) Wabash River Ordnance Works. Title IV. Supplemental Agreement No. 6 to Contract W-ORD-556, DA-W-ORD-38.

Estimated monthly operating cost, \$321,800.

Estimated monthly production, 2400 lbs. (38,400 "units").

Operating fee, \$9.28 per lb. for first 2400 lbs. per month; \$4.80 per lb. for each additional lb. per month. (\$0.68 and \$0.30 per "unit" respectively).

Minimum fee, \$10,700 per month.

(3) Alabama Ordnance Works. Title III, Supplemental Agreement No. 13 to Contract No. W-ORD-526, DA-W-ORD-1.

Estimated monthly operating cost, \$212,000.

Estimated monthly production, 1600 lbs. (25,600 "units").

Operating fee, \$9.28 per lb. for first 1600 lbs. per month; \$4.80 per lb. for each additional lb. per month (\$0.68 and \$0.30 per "unit" respectively).

Minimum fee, \$7,000 per month.

(4) General.

(a) The minimum fee at each plant was provided because of the uncertainty of the results, in order to avoid too great loss to the operating contractor in case of inability to attain the hoped for production; the scales of fees per pound were designed to offer an incentive toward increasing production. In any case, the whole schedule of fees must be regarded as extremely

low when the time and effort expended on this work by key personnel of the du Pont Company are considered -- especially in proportion to the overall work of the company.

(b) Because of the extreme uncertainty of the results, the contractor could not be required to guarantee performance or meeting the specifications of the product, at any of the three plants.

(c) The combined total of the payments for operating fees for each month was based on the total amount of finished product drawn from the electrolytic finishing plant at Morgantown. As it was necessary to feed the unfinished product of the three distillation plants to the finishing plant from a common supply, an equitable formula was devised for crediting the proper share of finished product to each of the plants, in proportion to the amount of unfinished product supplied by each, and the separate fee for each plant was calculated accordingly. (App. D36).

b. Procedure.

In the supervision and administration by the Government of operations at the three plants, certain functions were assumed by the Manhattan District and others were assumed by the Ordnance Department. The divisions of authority and function were worked out carefully between representatives of the two agencies, in order to avoid all unnecessary duplications of personnel and facilities while maintaining the desired secrecy and control. In general, the Ordnance Commanding Officer at each plant is charged with the

administrative duties pertaining to operation and the Manhattan District Engineer is responsible for technical supervision of operation, including control of the quantity and quality of the product. The detailed arrangements are set forth in a letter from the Field Director of Ammunition Plants, Office of the Chief of Ordnance, addressed to each Commanding Officer at Morgantown Ordnance Works, Wabash River Ordnance Works and Alabama Ordnance Works respectively. (See letter to C. O. at Morgantown, 4 June 1943, Appendix D37).

c. History of Operation. (App. D38).

(1) Start-up. Because of the urgency for getting the plants into production and the length of time required to bring them into equilibrium, the individual processing units were placed in operation as soon as the completion status of each would permit. The start-up dates may be summarized as follows:

(a) Morgantown Ordnance Works.

First Unit: 29 May 1943

Last Unit: 28 August 1943

(b) Wabash River Ordnance Works.

First Unit: 17 June 1943

Last Unit: 18 September 1943

(c) Alabama Ordnance Works.

First Unit: 29 May 1943

Last Unit: 4 September 1943.

Manufacture of the product started, officially, 1 July 1943.

(2) Production.

(a) It was initially estimated that a total production of 2.4 tons, or 4800 pounds, of F-9 per month would be obtained from the plants within the United States (800 lbs. at Morgantown; 2400 lbs. at Wabash River; and 1600 lbs. at Alabama). The contract provisions clearly indicate, however, that this rate of production could not be assured, because of absence of precedent for manufacture of the product, and it became evident during the early stages of production that the original estimate was over-optimistic. This conclusion was reached despite the hopes raised by promising rates of production during the first months of operation. New estimates were made on various successive dates, each one indicating a progressive downward revision of anticipated maximum monthly production and a progressive postponement to a later date (except in the case of the last estimate) of the anticipated maximum attainment. The original estimate and the succeeding revisions thereof are shown in the tabulation which follows (App. D39). The figures of actual production, as drawn from the finishing plant at Morgantown, have been inserted for comparison.

~~SECRET~~

Month	Original	PRODUCTION ESTIMATES				Actual Production
		21 Jan 1944	5 Apr 1944	5 May 1944	12 June 1944	
Jan. 1944	4800	-	-	-	-	914
Feb.	4800	3000	-	-	-	2488
Mar.	4800	4000	-	-	-	2839
Apr.	4800	4400	3000	-	-	3020
May	4800	4400	3500	2500	0	2074
June	4800	4400	3500	3000	2250	2241
July	4800	4400	4000	3000	2500	1995
Aug.	4800	4400	4000	3500	2500	1299
Sept.	4800	4400	4000	3500	2500	2114
Oct.	4800	4400	4000	3500	2500	2254
Nov.	4800	4400	4000	3500	2500	2015
Dec.	4800	4400	4000	3500	2500	2202
Jan. 1945	4800	4400	4000	3500	2500	2203
Feb.	4800	4400	4000	3500	2500	2205
Mar.	4800	4400	4000	3500	2500	2201
Apr.	4800	4400	4000	3500	2500	2307
May	4800	4400	4000	3500	2500	2504
June	4800	4400	4000	3500	2500	2509
July	4800	4400	4000	3500	2500	2203
Aug.	4800	4400	4000	3500	2500	2592
Sept.	4800	4400	4000	3500	2500	1963

(To make the comparison complete, the estimated figure for maximum production has in each case been repeated from month to month through September 1945. After September 1945 the plants were in complete stand-by).

(b) The production of semi-finished product at each of the three distillation plants, in terms of percentages of the quantities originally estimated, is shown on the following graph:

~~SECRET~~

~~SECRET~~

% of Ori-
ginal Est.

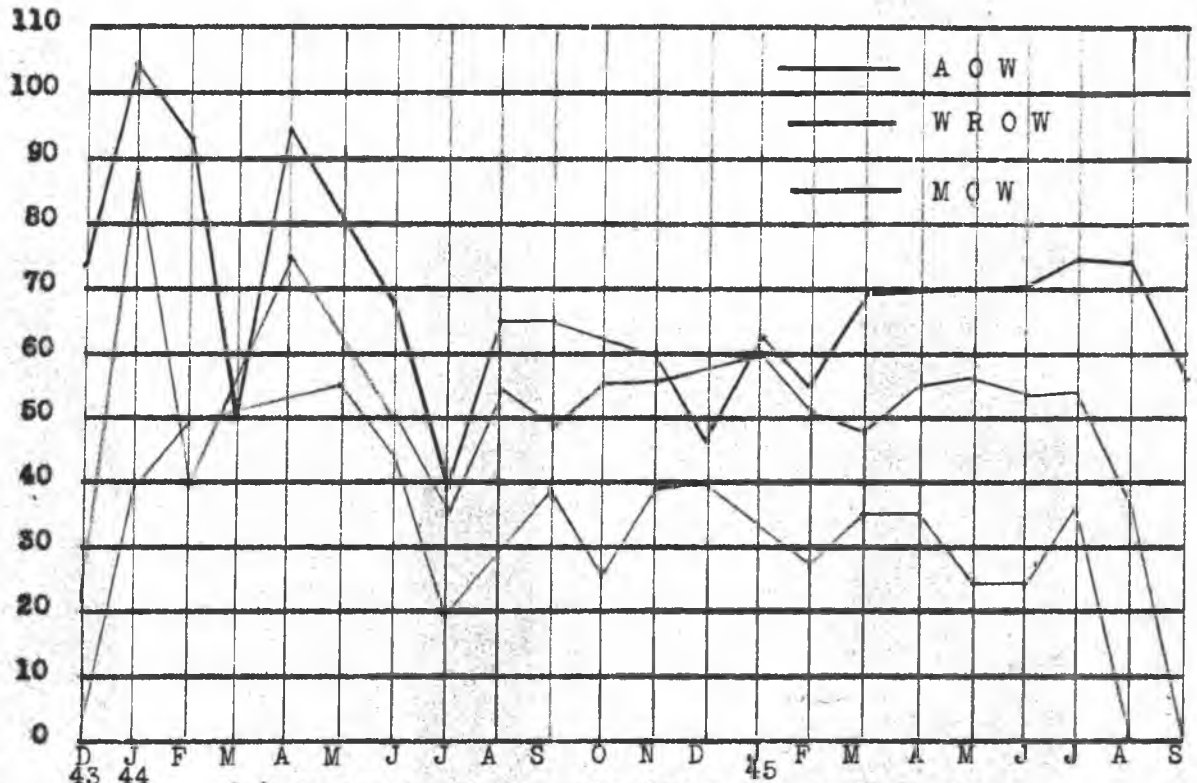

(e) Production during the first two months, par-

ticularly at Morgantown and Wabash River Ordnance Works, encouraged the belief that total overall performance might soon approach closely the original estimate, which was reduced in the first revision (in January 1944) by less than ten percent. At that time critical mechanical defects had not become apparent and there was no evidence that the factors used in designing the distillation plants were in error. The early hopes were short-lived, however, as various adverse factors began to appear. These may be briefly described as follows:

~~SECRET~~

(1) Power failures and similar interruptions to continuous operation, although of a temporary nature, proved to be extremely detrimental in disturbing the flow balance through the process train.

(2) Other performance difficulties were encountered, such as: obstruction to flow through the packing at the final stage of the distillation train; process piping and apparatus leakage; and fouling of the final stage candelarias.

(d) The conditions described above led to the second revision of the original estimate and to the following attempts to improve production:

(1) Boil-up rates were increased in an effort to move the product through the distillation train at a faster rate. The anticipated benefits failed to materialize, however, and the previous rates were again resumed.

(2) All distillation trains were operated on a direct draw-off system, to simplify the control problem. This modification likewise failed to produce the anticipated results.

(e) After a sporadic increase, production followed a definite downward trend, which led to the further revisions of the production estimates, on 5 May and 12 June 1944.

(f) Attempts to improve conditions were continued (App. D40, D41), culminating in:

(1) A temporary discontinuance of the draw-off from the distillation plants, in July 1944, to permit

internal concentrations to build up. This action was responsible in large measure for the extremely low performance recorded for this month, as shown on the chart. The chart also indicates that this action had no measurable effect on production during the period following the month of July.

(2) Investigation and partial correction of the tower plate efficiencies as described hereinafter.

(g) An independent committee of consultants, composed of Dr. W. K. Lewis, Massachusetts Institute of Technology, Chairman, Dr. Ernest Thiele of the Standard Oil Company of Indiana (formerly with the Standard Oil Development Company and consultant on the heavy water project at Trail, B. C.) and Mr. E. S. Farrow of Eastman Kodak Company, was called upon for advice. This committee investigated P-9 production at the Morgantown Ordnance Works and submitted a report to the District Engineer under date of 12 August 1944 (App. D42).

(h) The principal conclusions of this committee were: that the primary difficulty appeared to be low plate efficiency of the first stage distillation units; and that the main causes of this condition were: (1) leakage of liquid from the plates; (2) irregularities in the flow of vapor and liquid over the plates.

(i) The committee suggested consideration of the following corrective measures in the first stage units:

(1) Elimination of leakage and improvement of flow by modification of the plate arrangement, particularly by

elimination of some of the caps.

(2) Installation of higher chimneys.

(The term "chimney" refers to a part of the bubble cap assembly which consists of a vertical section of pipe extending above the bubble cap plate, above which is fastened the hemispherical cap. This corrective measure involved also the elimination of leakage and modification of plate construction).

(3) Construction of new modified first stage units, as an alternate to revamping existing units.

(j) The following action was taken, on the recommendation of the operating contractor, 25 August 1944 (App. D43) approved and authorized by the Manhattan District 9 September 1944.

(1) One pair of first stage towers at the plant at Morgantown Ordnance Works (one 15' and one 12' diameter) were completely dismantled; all plates were repaired to reduce by-pass leaks to a minimum.

(2) One-third of the bubble caps on all plates of the 12' tower were removed in order to reduce hydraulic gradient thereon.

(3) All seams and joints at all plates of both towers, which permitted leakage and by-pass of liquid within the towers, were gasketed or welded.

(k) This action was taken for the purpose of establishing the practicability of this method of improvement of

~~SECRET~~

production. The repair and revision of one pair of towers only could not of course affect overall production appreciably, but if it proved successful a complete program of reconstruction could be undertaken later.

(l) The action taken in effecting the sample reconstruction of the pair of towers at Morgantown was one of the proposals submitted by the special committee of consultants, as described above. The committee's proposal which involved the installation of tall chimneys was not followed, because it would not have been practicable (in the event that the trial improvement should prove satisfactory) to make similar improvements on all the remaining towers at the three plants, as this would involve procurement and installation of about one and a third million new plate chimneys.

(m) The revisions and improvements to the two towers at Morgantown were completed 4 November 1944, at a cost of about \$72,000. The towers were out of operation for 24 days and the comparatively small reduction in total operating capacity which these two towers represent, for this period, did not seriously affect the total overall production. (This work was performed under the construction contract and its cost is included in the construction costs).

(n) Operation of the plant at Morgantown after completion of the corrective work indicated that the two first stage towers were operating at very close to design efficiency. The oper-

~~SECRET~~

ating contractor submitted (on 3 January 1945) an estimate of about \$2,200,000 for similar reconstruction of all the remaining first stage towers at Morgantown, Wabash River and Alabama. It was also estimated that this work would require about six months to complete, and it was forecast that it would bring the total output of the three plants up to approximately 90% of the original design capacity. (App. D44).

(o) Although inadequate plate efficiencies in the large towers of the first stage thus appears to have been definitely established as the major cause of production rates continuing lower than those which were originally expected, the other adverse factors which were previously described also contributed to the record. Of these other factors, the fouling of the calorifiers, produced by tube failures, has been most difficult to overcome (App. D38).

(p) Decision was made by General Groves not to authorize similar reconstruction of all first stage towers because it was estimated that an approximate balance between supply and demand for heavy water would be reached by the time the proposed work could be completed and the increased output made available.

(q) In March 1945 the Ordnance Department advised the Manhattan District that they were planning to install additional steam boiler facilities at the Wabash River Ordnance Works, at a cost of \$3,000,000 to \$4,000,000. A review of requirements indicated that the heavy water plant at that site

~~SECRET~~

could probably be shut down in the summer of 1945 and the steam capacity of the plant made available for the operation of the Ordnance Works. The Ordnance Department was advised accordingly and were thus relieved of the necessity of installing the additional boilers.

(f) The shutdown of the three duPont Ordnance P-8 plants was executed on the following dates:

Alabama Ordnance Works	June 30 , 1945
Wabash River Ordnance Works	July 31, 1945
Morgantown Ordnance Works:	
Distillation	August 31, 1945
Finishing	September 30, 1945

This schedule of shutdown was prearranged on the basis that the known overall cumulative required quantities of the product to be expected from these three plants was satisfactorily attained. Upon termination of operations each plant was placed in indefinite standby condition. The monthly costs of maintaining these plants in standby were originally as follows:

Morgantown Ordnance Works	\$1500
Alabama River Ordnance Works	1200
Wabash River Ordnance Works	1350

Later due to a modification in security provisions at each of the plants, the costs were reduced in April, 1946, as follows:

Morgantown Ordnance Works	\$ 750
Alabama Ordnance Works	425
Wabash River Ordnance Works	750*

*Further reduced to \$600 on December 31, 1946.

(d). Production Records. (App. D45).

The tabulation which follows shows the monthly record of production of heavy water at the three plants in the United States, from the start-up of operation. The figures in the "Finished Total" column are the quantities of finished product drawn from the electrolytic finished plant at Morgantown Ordnance Works; the figures in the respective plant columns are the quantities of semi-finished product supplied to the electrolytic plant from each distillation plant, and

~~SECRET~~

~~SECRET~~

the totals of these are shown in the "Semi-Finished-Total" column.

Month	Production in Pounds				Finished Total
	Semi-Finished			Total	
	Morgantown	Wabash River	Alabama		
December 1943	559	536	-	1,125	-
January, 1944	621	2,051	602	3,474	914
February	729	984	770	2,483	2488
March	382	1,553	778	2,493	2939
April	755	1,792	831	3,378	3020
May	629	1,536	888	3,051	2074
June	521	1,256	681	2,458	2241
July	511	705	314	1,528	1995
August	507	1,353	459	2,319	1299
September	504	1,171	612	2,287	2114
October	486	1,327	362	2,177	2254
November	462	1,310	611	2,383	2016
December	561	1,322	630	2,313	2202
January, 1945	493	1,480	525	2,498	2203
February	416	1,209	468	2,093	2203
March	531	1,099	569	2,199	2201
April	571	1,324	570	2,465	2307
May	559	1,356	475	2,390	2504
June	557	1,292	445	2,294	2509
July	593	1,285	587	2,465	2203
August	584	871	0	1,455	2592
September	454	0	0	454	963

The total cumulative production to the end of September 1945 was 45,140, and the average monthly production from January, 1944 through September, 1945 was 2150 pounds. (This does not include 726 pounds of special product (90% enriched) and 3151 pounds of material recovered in Germany and reworked to product specifications in the finishing plant).

~~SECRET~~

e. Production Costs.

(1) Operating Costs and Operating Fees. (App. D46).

(a) The total monthly operating costs of the three heavy water plants were originally estimated in the contracts as follows: (App. C2 and D47).

<u>Plant</u>	<u>Est. Operating Cost</u>
Morgantown Ordnance Works	\$ 72,400
Wabash River Ordnance Works	321,800
Alabama Ordnance Works	<u>212,000</u>
Total	\$ 606,200

The considerably lower cost for Morgantown was estimated not only on account of its lower design capacity but also because of the following factors:

(1) Coal charges were substantially lower in West Virginia than in Alabama and Indiana; also, cheap coke oven gas was available for the low pressure boilers at Morgantown; therefore, unit costs of steam were lower.

(2) The costs of raw water units were lower at Morgantown because the design and layout of the existing Ordnance plant permitted the use of a cooling tower.

The estimate for Morgantown included an item of \$3,000 for investigations to increase capacity and reduce costs. Although this work was to be carried on at Morgantown, its results were applicable to all three plants and therefore this item might theoretically have been proportioned among them.

~~SECRET~~

(b) The actual operating costs per month and the actual operating fees for each plant and the total production costs per pound during the month are shown in the accompanying table.

~~SECRET~~

Month	Operating Cost				Operating Fee				Total Prod Cost
	M.O.W.	W.R.O.W.	A.O.W.	Total	M.O.W.	W.R.O.W.	A.O.W.	Total	
June 43		8,406.99		8,406.99					8,406.99
July**	46,605.02	61,195.47	41,799.14	149,599.63	2,400.00	10,700.00	7,000.00	20,100.00	169,699.63
Aug.	47,390.98	127,888.57	82,129.85	257,399.40	2,400.00	10,700.00	7,000.00	20,100.00	277,499.40
Sept.	53,316.52	179,366.16	114,411.07	347,093.75	2,400.00	10,700.00	7,000.00	20,100.00	367,193.75
Oct.	51,960.41	199,146.06	142,642.77	393,749.24	2,400.00	10,700.00	7,000.00	20,100.00	413,849.24
Nov.	52,277.92	194,739.87	130,400.47	377,418.26	2,400.00	10,700.00	7,000.00	20,100.00	397,518.26
Dec.	61,400.28	198,683.77	143,799.30	403,883.35	2,400.00	10,700.00	7,000.00	20,100.00	423,983.35
Jan. 44	62,410.24	215,162.56	153,115.03	430,687.83	2,400.00	10,700.00	7,000.00	20,100.00	450,787.83
Feb.	63,418.31	204,130.93	141,131.57	408,680.81	4,865.00	12,387.06	7,000.00	24,252.06	432,932.87
Mar.	72,700.05	208,423.93	171,748.30	452,872.28	4,568.36	12,895.14	7,000.00	24,463.50	477,335.78
Apr.	74,353.79	193,508.51	155,777.54	423,639.84	3,521.46	14,736.64	7,918.16	26,176.26	449,816.10
May	71,231.75	206,578.18	161,246.68	439,056.61	3,197.70	10,700.00	7,000.00	20,897.70	459,954.31
June	70,523.18	193,196.43	140,158.37	403,877.98	2,700.28	10,700.00	7,000.00	20,400.28	424,278.26
July	69,296.31	187,833.55	143,116.91	400,246.77	2,578.68	10,700.00	7,000.00	20,278.68	420,525.45
Aug.	69,810.93	185,295.01	158,713.18	413,819.10	2,400.00	10,700.00	7,000.00	20,100.00	433,919.10
Sept.	73,339.64	185,579.10	147,132.87	406,051.61	2,948.80	11,632.48	7,000.00	21,581.28	427,632.89
Oct.	69,953.70	180,054.70	139,805.59	389,813.99	2,936.64	11,467.18	7,000.00	21,403.82	411,217.81
Nov.	69,943.55	181,062.98	142,006.79	393,013.32	2,684.32	10,700.00	7,000.00	20,384.32	413,397.64
Dec.	74,342.19	185,531.76	153,649.80	413,523.75	2,880.40	11,614.50	7,000.00	21,494.90	435,018.65
Jan. 45	73,436.15	184,577.95	156,031.40	414,045.50	2,400.00	11,481.10	7,000.00	20,881.10	434,926.60
Feb.	68,605.11	180,432.08	136,484.01	385,521.20	2,400.00	12,009.48	7,000.00	21,409.48	406,930.68
Mar.	64,125.80	187,316.79	148,979.10	400,421.69	2,618.58	11,836.08	7,000.00	21,454.64	421,876.33
Apr.	64,633.51	182,365.40	136,660.29	383,659.20	3,222.40	11,685.84	7,000.00	21,908.24	405,567.44
May	66,078.59	183,813.74	134,742.35	384,634.68	3,443.18	12,139.40	7,000.00	22,582.58	407,217.26
June	66,149.06	170,480.25	131,473.04	368,102.35	3,537.42	12,696.78	7,000.00	23,234.20	391,336.55
July	62,931.03	141,256.61	15,713.77	219,901.41	5,333.74	12,055.88	3,308.32	18,697.94	238,599.35
Aug.	62,747.45	28,813.02	0.00	91,560.47	3,765.80	11,736.88	6,571.98	22,074.66	113,635.13
Sept.	35,236.11	0.00	0.00	35,236.11	2,727.64	7,917.00	1,001.66	11,646.30	46,882.41
Avg.****	68,822.00	185,630.00	146,992.00	361,383.93	3,158.00	11,785.00	7,054.00	21,266.10	423,400.00***

*Because of the time lag between the water distillation and the electrolytic finishing processes, the figures in this exactly the costs per pound of the finished material produced during each month, but they are the closest approximat

**Includes costs for July, 1943 and preceding months.

***The summation here shown does not represent the total cost for operation up to December 31, 1946. Additional item to date shown by this tabulation. The total production cost is shown by paragraph 5-2 e (2).

****Columns 1, 2, 3, 5, 6 & 7 based on costs from Feb. 44 to standby for each plant; columns 9 & 10 to standby of all 4 & 8 through September 45.

I-27 #1

Operating Cost			Operating Fee			Total Prod Cost	Total Prod Pounds	Prod. Cost Per Pound*
W.R.O.W.	A.O.W.	Total	M.O.W.	W.R.O.W.	A.O.W.	Total		
8,406.99		8,406.99					8,406.99	
61,195.47	41,799.14	149,599.63	2,400.00	10,700.00	7,000.00	20,100.00	169,699.63	
127,888.57	82,129.85	257,599.40	2,400.00	10,700.00	7,000.00	20,100.00	277,499.40	
179,366.16	114,411.07	347,093.73	2,400.00	10,700.00	7,000.00	20,100.00	367,193.75	
199,146.06	142,642.77	395,749.24	2,400.00	10,700.00	7,000.00	20,100.00	413,849.24	
194,739.87	130,400.47	377,418.26	2,400.00	10,700.00	7,000.00	20,100.00	397,518.26	
198,683.77	143,799.30	405,883.35	2,400.00	10,700.00	7,000.00	20,100.00	423,983.35	
215,162.56	153,115.03	430,687.83	2,400.00	10,700.00	7,000.00	20,100.00	450,787.83	914
204,130.93	141,131.57	408,680.81	4,865.00	12,387.06	7,000.00	24,252.06	432,932.87	2,488
208,423.93	171,748.30	452,872.28	4,568.36	12,895.14	7,000.00	24,463.50	477,335.78	2,839
193,508.51	155,777.54	423,639.84	3,521.46	14,736.64	7,918.16	26,176.26	449,816.10	3,020
206,578.18	161,246.68	439,056.61	3,197.70	10,700.00	7,000.00	20,897.70	439,954.31	2,074
193,196.43	140,158.57	403,877.98	2,700.28	10,700.00	7,000.00	20,400.28	424,278.26	2,241
187,833.55	143,116.91	400,246.77	2,578.68	10,700.00	7,000.00	20,278.68	420,525.45	1,996
185,295.01	158,713.16	413,819.10	2,400.00	10,700.00	7,000.00	20,100.00	433,919.10	1,299
185,579.10	147,132.87	406,051.61	2,948.80	11,632.48	7,000.00	21,681.28	427,632.89	2,114
180,054.70	139,805.59	389,813.99	2,936.64	11,467.18	7,000.00	21,403.82	411,217.81	2,254
181,062.98	142,006.79	393,013.32	2,684.32	10,700.00	7,000.00	20,384.32	413,397.64	2,015
185,531.76	153,649.80	413,523.75	2,880.40	11,614.50	7,000.00	21,494.90	435,018.65	2,202
184,577.95	156,031.40	414,045.50	2,400.00	11,481.10	7,000.00	20,881.10	434,926.60	2,203
180,432.08	136,484.01	385,521.20	2,400.00	12,009.48	7,000.00	21,409.48	406,930.68	2,203
187,316.79	148,979.10	400,421.69	2,618.58	11,836.06	7,000.00	21,454.64	421,876.33	2,201
182,365.40	136,660.29	383,659.20	3,222.40	11,685.84	7,000.00	21,908.24	403,567.44	2,307
183,813.74	134,742.35	384,534.68	3,443.18	12,139.40	7,000.00	22,582.58	407,217.26	2,504
170,480.25	131,473.04	368,102.35	3,537.42	12,696.78	7,000.00	23,234.20	391,336.53	2,509
141,256.61	15,713.77	219,901.41	3,333.74	12,055.88	3,308.32	18,697.94	238,599.35	2,203
28,813.02	0.00	91,560.47	3,765.80	11,736.88	6,571.98	22,074.66	113,635.13	2,592
0.00	0.00	35,236.11	2,727.64	7,917.00	1,001.66	11,646.30	46,882.41	963
185,630.00	146,992.00	361,383.93	3,158.00	11,785.00	7,064.00	21,266.10	423,400.00 ***	2,277

SECRET

no lag between the water distillation and the electrolytic finishing processes, the figures in this column do not represent per pound of the finished material produced during each month, but they are the closest approximation obtainable.

for July, 1943 and preceding months.

are shown does not represent the total cost for operation up to December 31, 1946. Additional items were accrued subsequent to this tabulation. The total production cost is shown by paragraph 5-2 e (2).

5, 5, 6 & 7 based on costs from Feb. 44 to standby for each plant; columns 9 & 10 to standby of all three plants and columns 11 to standby for each plant on August 45.

5-27-42

~~SECRET~~

As shown, the average production cost per pound of the total production during the period February 1944 to September 1945 inclusive was \$186. It will be noted that there has been one extreme variation from this average during the 20 months, in the month of August 1944, when finished production was low because of the experiment of temporarily discontinuing the draw-off from the distillation plants, as previously explained.

(2) Total Cost per Pound of Product.

If the amortisation of the total cost of the three plants (\$14,743,211) is added to the cost of operation from the startup to the cessation of operation, 30 September 1945, the overall cost per pound of heavy water produced in the duPont Ordnance P-9 plants may be calculated as follows:

To 30 September 1945 (Shutdown):

Cost of Construction, etc. (Incl. O&RD)	\$14,743,211
Total Production Costs	<u>10,292,454</u>
Total Costs	\$25,035,665
Total Production*	45,865.5 lbs.
Total Cost per Pound	\$550

*Includes 725 pounds of special Product (90%)

~~SECRET~~

~~SECRET~~

6-3. Recapitulation.

a. Production Records.

(1) The total cumulative production to 31 December 1948 was as follows:

For the Plant at Trail, B. C.	36,330
For the Three U. S. Plants:	
Regular Product	45,140
Special Product (90%)	726
German Reworked Product	<u>3,151</u>
Total	<u>85,347</u>

(2) This total is increasing at the rate of approximately 1100 pounds per month.

(3) As has been explained previously the rates of production at the various plants did not meet the expectations held in the earliest stages of the project. In dealing with a comparatively new material and comparatively new processes never before attempted for quantity production this is not surprising; it merely indicates that the scientists and engineers may have set their sights too high. Nevertheless, no one connected with the various parts of the project was content to let the lowered rates of production continue; on the contrary, all concerned have made every effort to find and eliminate flaws in operation and devise ways and means for improving the production record, consistent with sound policies and economies. The experimental improvements which have been tried out at the plant at Morgantown have indicated that if the Government's demands for heavy water were increasing, instead of diminishing, the installation of similar improvements throughout the three plants in the United States which would then be justified might effect material

~~SECRET~~
6.29

increases in the rates of production and might bring them close to the design figures.

b. Production Costs.

The total cumulative production costs to 31 December 1946 were as follows:

For the Plant at Trail, B. C.	\$ 1,418,120
For the three U. S. Plants	<u>10,230,454</u>
Total	\$11,648,574

This total is increasing at the monthly rate of about \$59,000 for Trail production, plus \$1175 required to maintain the three U. S. plants in standby.

c. Total Cost per Pound of Product.

(1) The total cost per pound of product, including amortization of the total costs of construction, etc., as of 31 December 1946 is as follows:

For the Plant at Trail, B. C.	\$111
For the three U. S. Plants	550

The average total cost per pound for the entire production from all four plants might be calculated as follows:

Total Costs of Construction, etc.	\$17,347,855
Total Production Costs	<u>11,648,574</u>
Total Cost	\$28,996,407
Total Production	81,470 lbs.
Average Total Cost per Pound	\$356

(2) This high average total cost per pound is of course due primarily to the short periods of operation during which

~~SECRET~~

the entire construction costs of the four plants have been assumed to be amortized: about $2\frac{1}{2}$ years for the plant at Trail, B. C., and 2 years for the three plants in the United States. In the last month for which complete figures are available, March, 1945, the production cost was \$30 per pound at Trail and \$192 per pound at the three U. S. plants, or an average of \$142 per pound. If production should continue and if the production rate at the three plants in the United States were increased by means of the improvements which have now been devised, the average total production cost for, say, 5000 lbs. of product per month might be reduced to about \$90 per pound. This would represent the average total additional cost, exclusive of amortization, or the average total cost over and above expenditures which would have been already made.

(3) The lower costs of production at the Trail plant as compared with those at the other plants result to a considerable extent from the fortunate circumstance that hydrogen was already being produced by the CMAS Company, with facilities already existing. Therefore the heavy water was in effect a by-product of the existing plant, and the costs of an important large part of the process are not fully reflected in the costs of the product. To have constructed in the United States, a complete plant, from the ground up, for the production of heavy water by this same process, might have developed a cost per pound in excess of the costs at the distillation plants.

5-4. Shipments of Material.

Shipment of partially concentrated material from the Alabama

~~SECRET~~

~~SECRET~~

and Wabash River distillation plants to the Morgantown electrolytic plant for final concentration is made by Railway Express under a "Money" receipt, in sealed, special metal containers. Notice of shipment is made by registered mail and the recipient is notified of container seal numbers so that they can be checked for evidences of tampering. Deliveries from the plants to the Railway Express office and from the terminal Express office to the Morgantown plant are made by special truck. The frequency of shipment and material shipped is unknown to anyone except certain selected individuals.

Shipment of finished product from the Trail Plant and from the Morgantown Ordnance Works to the University of Chicago, Chicago, Illinois is also handled by Railway Express under "Money" or "Registered" (Canadian) receipts with similar provisions for notice of shipment, numbered seals, pickup and delivery by special trucks, as are described above for the partially concentrated material.

~~SECRET~~

~~SECRET~~

SECTION 6 - ORGANIZATION AND PERSONNEL

6-1. Administration.

a. The Government organization and personnel for the overall administration of the P-9 Project are set forth in Book I. The organization of the OSRD, the S-1 Committee, the Military Policy Committee and the Manhattan District, and their connection with the DSM Project as a whole, are there described.

b. Before the project was fully organized, the preliminary work was carried out under the direction of the OSRD, with General W. D. Styer, Chief of Staff, S.O.S., being kept informed.

c. The project was placed under Colonel J. C. Marshall who served as District Engineer of the Manhattan District from 19 June 1942 until he was relieved by Colonel K. D. Nichols on 20 July 1943. Colonel Nichols has served continuously as District Engineer since that time. On 23 September 1942 Major General L. R. Groves was selected by the Secretary of War to take complete executive charge of the entire project.

d. The personnel of the District Engineer's unit in direct charge of the development and production of this product has consisted of the following:

(1) Unit Chief, Construction and Operations: Major

H. S. Traynor.

Assistant Chief: Captain M. J. Farkett.

~~SECRET~~

(2) Construction.

Trail, B. C. Area: Major J. F. Sally.

(b) Morgantown Area: Major E. A. Brinkman,
succeeded by Captain W. A. Catlett,

(c) Wabash River Area: Major L. E. Rosback.

(d) Alabama Area: Captain W. G. Wells, suc-
ceeded by Captain Joseph H. King.

(3) Operation.

(a) Trail, B. C., Plant: Major J. F. Sally.

(b) Morgantown Plant: Captain W. A. Catlett,
succeeded by Captain M. J. Barnett.

(c) Wabash River Plant: Captain M. J. Barnett.

(d) Alabama Plant: Captain M. J. Barnett.

6-2. Research and Development Personnel.

a. Dr. H. C. Urey, Member of OSRD, of Columbia University.

b. Dr. E. V. Murphree, Member of OSRD,) of Standard Oil
Development Co.;

c. Dr. E. W. Thiele) development of
catalysts for the
Trail, B. C.,
Plant; construction
and operation of a
heavy water pilot
plant.

d. Dr. H. S. Taylor, of Princeton University; Development
of Catalysts.

e. Dr. M. Dole, Northwestern University) Heavy water
analysis methods
f. Dr. A. O. C. Nier, U. of Minnesota) & equipment

g. Dr. G. M. Webb, of Universal Oil Products Co.) Development of
Catalyst.

h. Dr. V. R. Thayer, of the du Pont Co.: Development of Distillation Process

6-3. Design Personnel.

a. Consolidated Mining & Smelting Co.; Trail, B. C.,

Dr. C. H. Wright.

b. Stone & Webster Engineering Corp., Mr. A.L. Hartridge,

Project Manager.

c. E. I. du Pont de Nemours & Co., Inc., Wilmington Office.

(1) Mr. E. G. Ackart, Chief Engineer, Engineering Department.

(2) Mr. Granville M. Read, Assistant Chief Engineer,

(3) Mr. Tom C. Gary, Manager of Design Division.

(4) Mr. F. A. Wardenburg) of the Ammonia Department;

(5) Dr. V. R. Thayer) general consultant services

(6) Dr. J. A. Monier) and technical supervision

(7) Dr. W. P. Bebbington) of process design.

6-4. Construction Personnel.

a. C M & S Co., at Trail, B. C., Mr. H. F. Teidje.

b. du Pont Company

(1) At Wilmington: Mr. E. G. Ackart and Mr. Granville M. Read.

(2) At Morgantown Ordnance Works: Mr. J. M.

Christman, Field Project Manager, succeeded by Mr. H. W. Frits.

(3) At Wabash River Ordnance Works: Mr. W. T. Tyles

Field Project Manager, succeeded by Mr. H. E. Fisher.

~~SECRET~~

(4) At Alabama Ordnance Works; Mr. W. V.

Krewatch, Field Project Manager.

6-5. Operating Personnel.

a. C M & S Co., at Trail, B. C., Dr. C. H. Wright;

Mr. J. Buchanan, Manager.

b. du Pont Co., general technical supervision of all three plants, Dr. J. A. Monier, Dr. W. P. Bebbington, and Dr. V. R. Thayer.

(1) At Morgantown Ordnance Works; Mr. Gordon Custer, Manager.

(2) At Wabash River Ordnance Works; Mr. H. S. Hopkins, Manager.

(3) At Alabama Ordnance Works; Mr. T. A. Jones, Manager.

c. Consultants during Operation. Many of the personnel listed in paragraph 6-2 above were consulted during operation. In addition, a special committee, composed of:

(1) Dr. W. K. Lewis, Chairman

(2) Dr. Ernest Thiele

(3) Mr. Edward S. Farrow

was called upon to advise in connection with the operation of the plants in the U. S., and submitted their report 12 August 1944.

~~SECRET~~

~~SECRET~~

6-6. General.

The successful attainment of the purpose of the project was due to the loyal, cooperative and unremitting efforts of all those listed above and many, many others, too numerous to mention.

6.5

~~SECRET~~

~~SECRET~~

APPENDICES

Appendix A. Drawings

- A1. Layout of plant at Trail, B. C., Canada
- A2. " Morgantown Ordnance Works
- A3. " Wabash River Ordnance Works
- A4. " Alabama Ordnance Works
- A5. Flow Diagrams, Trail Plant (with description)
- A6. Flow Diagram, Plants in U. S., Distillation
- A7. Flow Diagrams, Plant at Morgantown Ordnance Works,
 Electrolytic Finishing (with description)

Appendix B. Photographs

- B1. Trail Plant
- B2. Plant at Morgantown Ordnance Works
- B3. Plant at Wabash River Ordnance Works
- B4. Plant at Alabama Ordnance Works

Appendix C. Lists of Special Documents (in Files)

- C1. Technical Reports
- C2. Contracts

Appendix D. List of Other Data in Files

- App. Contents -

~~SECRET~~

~~SECRET~~

APPENDIX A

DRAWINGS

- A1. Layout of plant at Trail, B. C. Canada
- A2. Layout of plant at Morgantown Ordnance Works
- A3. Layout of plant at Wabash River Ordnance Works
- A4. Layout of plant at Alabama Ordnance Works
- A5. Flow Diagrams, Trail Plant (with description)
- A6. Flow Diagram, Plants in U. S., Distillation
- A7. Flow Diagrams, Plant at Morgantown Ordnance Works,
Electrolytic Finishing (with description)

App. A

~~SECRET~~

~~SECRET~~

A1. Layout of plant at Trail, B. C., Canada

App. A1

~~SECRET~~

SECRET

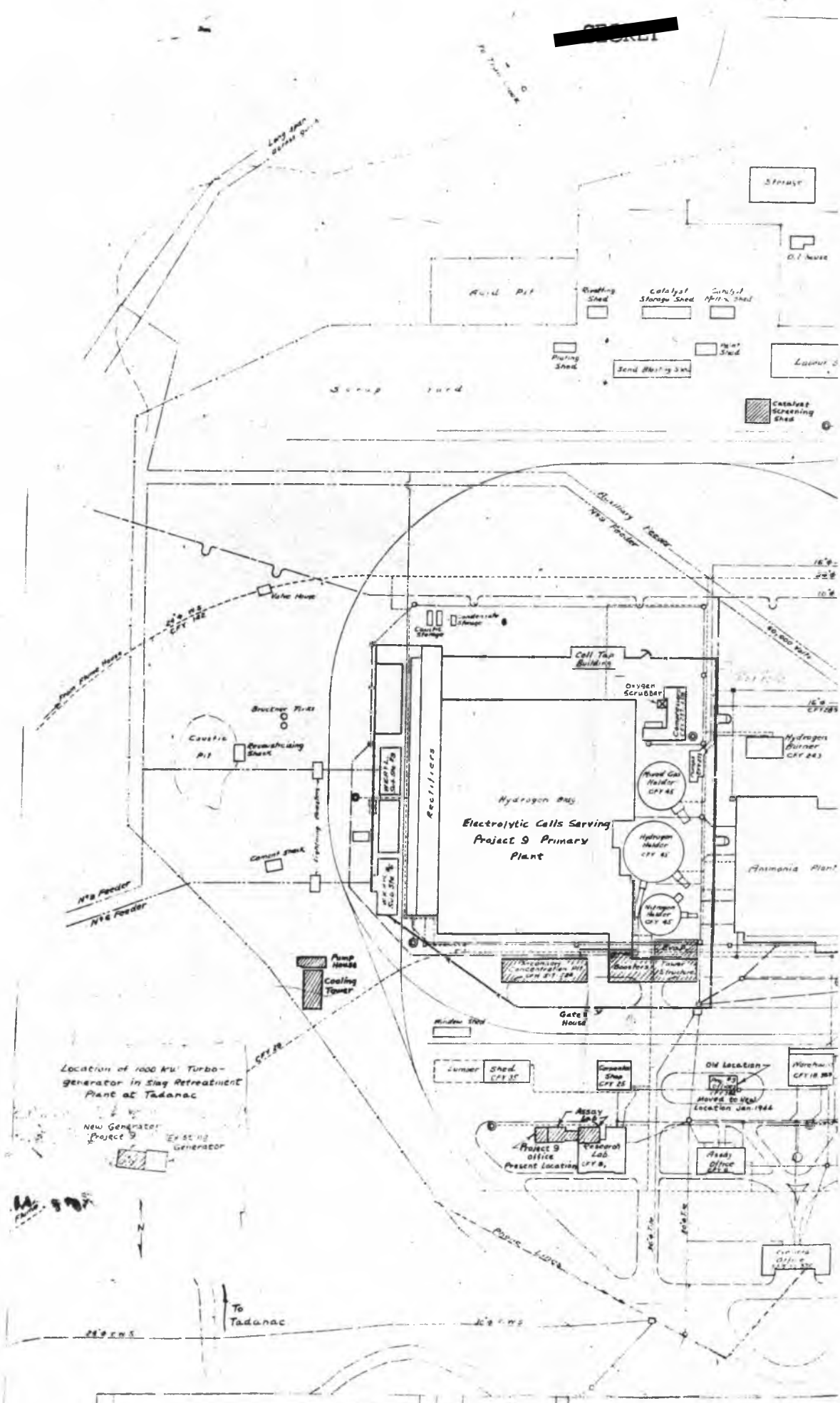

#2

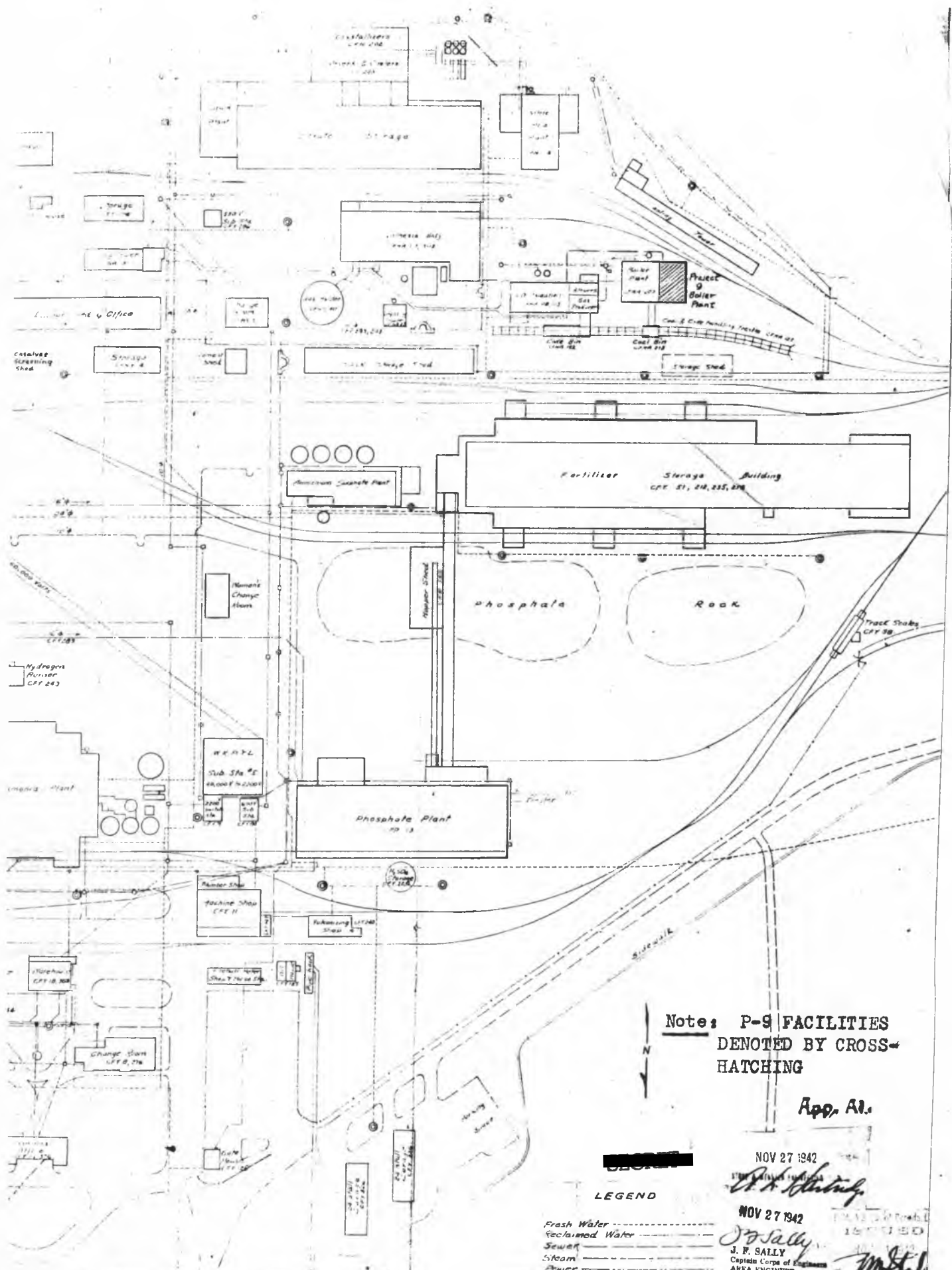

Note: P-9 FACILITIES DENOTED BY CROSS-HATCHING

App. At.



LEGEND

- Fresh Water
- - - Reclaimed Water
- Sewer
- Steam
- Power

NOV 27 1942

J. F. Sally

NOV 27 1942

J. F. Sally
 J. F. SALLY
 Captain Corps of Engineers
 ARMA ENGINEER

SCALE: 1" = 100'

C.F.Y. 376

DESIGNED BY: S.V.S.	NOV 16 '42	DEPARTMENT	CHEMICAL & FERTILIZER
CHECKED BY: [Signature]		DIVISION	YARDS
		SECTION	PLAN OF WARFIELD PLANTS SITE.

CONSOLIDATED MINING & SMELTING CO.
 OF CANADA LIMITED.
 TADANAC, B.C.
 P-9 PLANT

~~SECRET~~

A2. Layout of plant at Morgantown Ordnance Works

App. A2

~~SECRET~~

Morgantown Ord. Works

Ref. No. M-212

~~SECRET~~

Date: 1-20-44 Copy 2 OF 7

Series A File 11 OF 11

FIELD PROGRESS REPORT
(CONSTRUCTION)
PART-G

AREA NAME MORGANTOWN ORDNANCE WORKS
MORGANTOWN WEST VIRGINIA

PROJECT DESIGNATION P9

PERIOD ENDING 31 December 1943

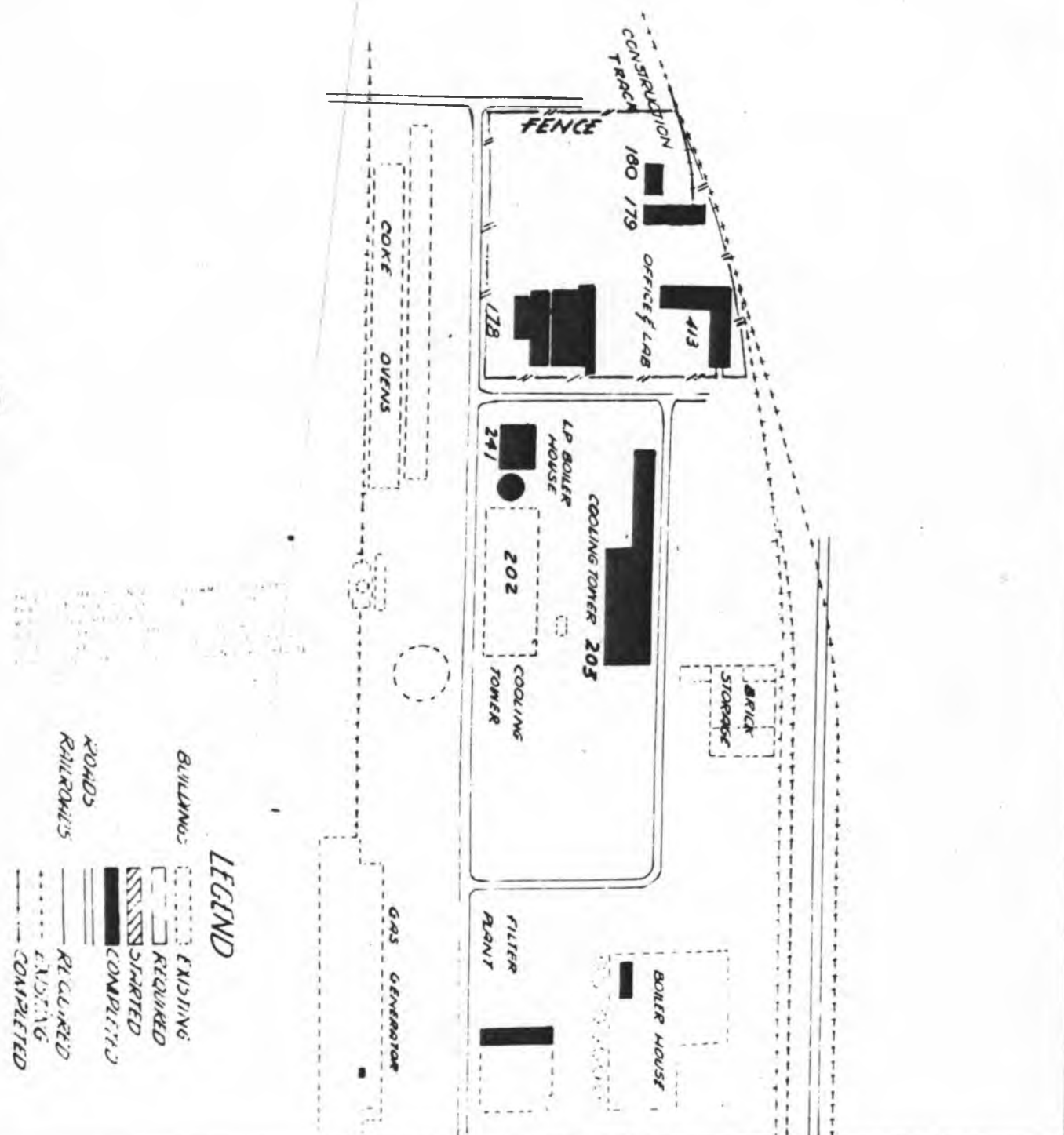

~~SECRET~~

A3. Layout of plant at Wabash River Ordnance Works

App. A3

~~SECRET~~

~~SECRET~~

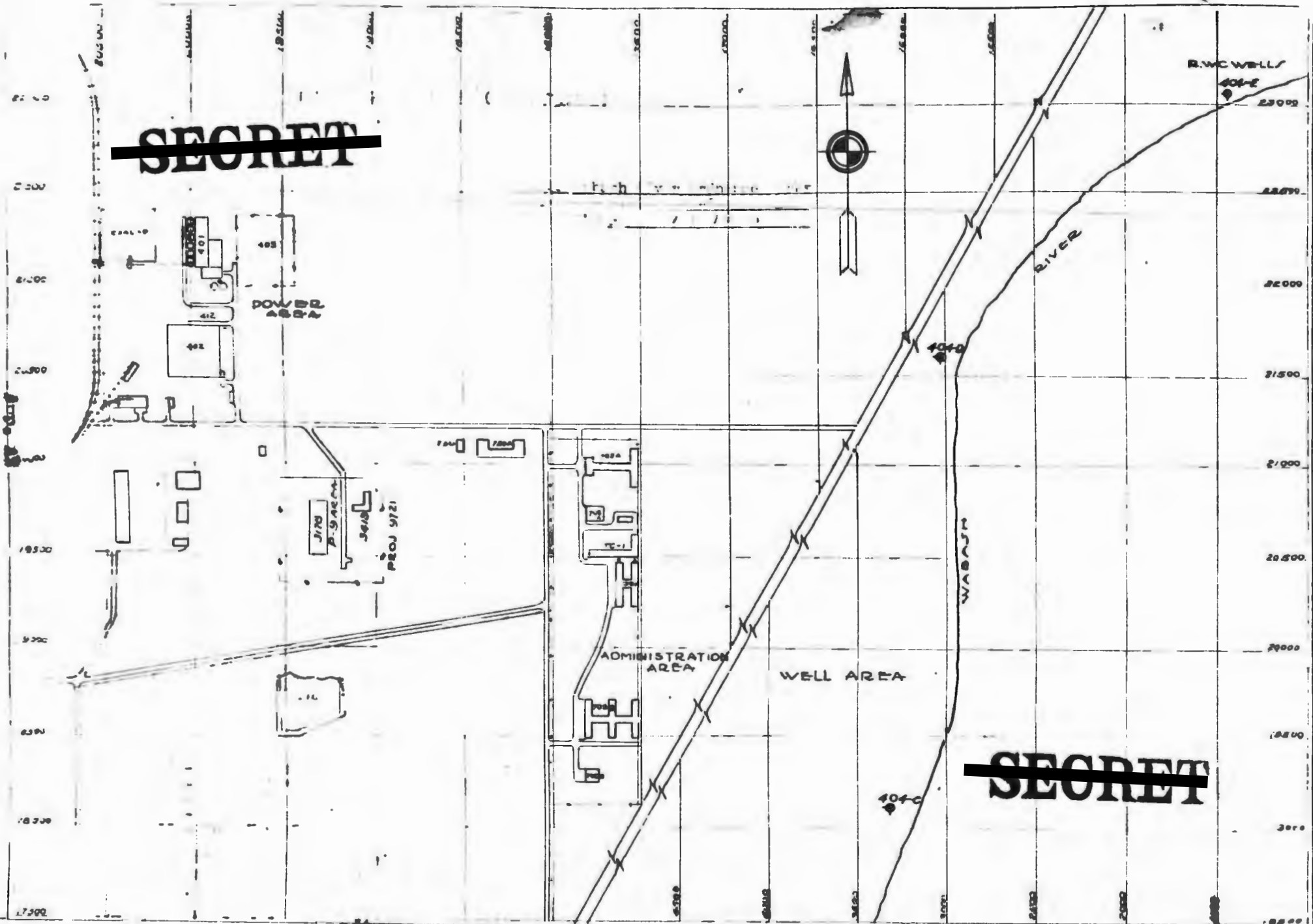

~~SECRET~~

~~SECRET~~

A4. Layout of plant at Alabama Ordnance Works

App. A4

~~SECRET~~

FIELD PROGRESS REPORT (CONSTRUCTION)

PART G **SECRET** AREA NAME ALABAMA ORDNANCE WKS
 SHEET 1 OF 1 PROJECT DESIGNATION P-9
 PERIOD ENDING 15 NOVEMBER 1943
 FINAL REPORT

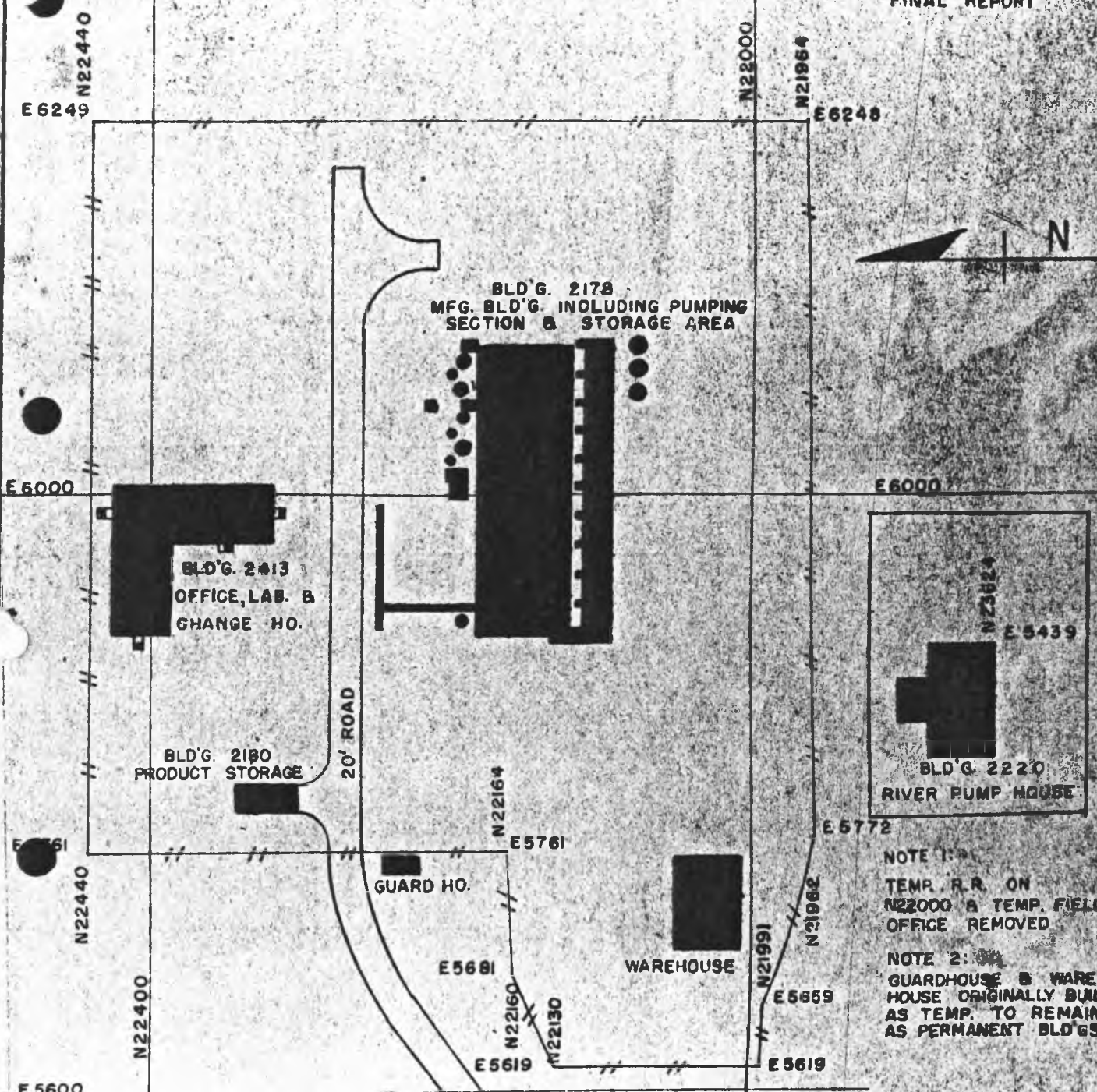

NOTE 1:
 TEMP. R.R. ON
 N22000 & TEMP. FIELD
 OFFICE REMOVED

NOTE 2:
 GUARDHOUSE & WARE-
 HOUSE ORIGINALLY BUILT
 AS TEMP. TO REMAIN
 AS PERMANENT BLD'GS.

LEGEND

- | | |
|----------------------|--------------------|
| BUILDINGS | SERVICES |
| REQ'D. | COMP. TEMP. CONST. |
| STARTED | COMP. FENCE |
| BENEFICIAL OCCUPANCY | COMP. R.R.(TEMP.) |
| | COMP. ROAD |

DETAIL PLOT PLAN
 ALABAMA ORDNANCE WORKS
 PROJECT 9722

TRACING	APPROVED BY <i>[Signature]</i> CAPT. G.E.	DRAWN BY J.O. MOONEY
3-31-43	APPROVED BY <i>[Signature]</i> CAPT. G.E.	MARCH 31, 1943 CHECKED BY J.O. Mooney

~~SECRET~~

APPENDIX A5

DESCRIPTION OF THE CM&S HEAVY WATER PLANT

The CM&S Heavy Water Plant at Trail, B. C. is designed to produce about 40 lbs. of final product (99.8% D₂O) per day. The complete operation comprises a Primary Concentration Plant and a Secondary Concentration Plant.

Primary Concentration Plant.

The object of the Primary Plant is to concentrate D₂O, which is present at a concentration of .015% in the feed water, to a concentration of about 2.3%. This concentration is effected in four stages of electrolytic cells and exchange towers. The primary plant produces about 2140 lbs of 2.3% heavy water per day which serves as feed to the secondary plant.

The following is a brief description of the process flow for the Primary Plant to accompany Figure 1. Table "A" gives a brief explanation of the various pieces of equipment.

The feed water, ordinary steam condensate, is fed to the top of the first stage exchange towers T1-A, B and C and on leaving the towers is fed to the first stage electrolytic cells. The water is electrolyzed and the generated hydrogen is sent through a condenser where the entrained electrolyte is separated out and sent to E1. The hydrogen moves from the condenser to the base of towers T1-A, B and C. At the base of each tower a reboiler is provided so that part of the water in the tower can be converted into vapor which is added to the hydrogen rising through the tower. In the tower

~~SECRET~~

~~SECRET~~

a catalytic exchange reaction takes place in which the deuterium in the hydrogen gas is transferred gradually to the water vapor



At the top of the towers condensers are provided by means of which most of the water vapor in the gases can be converted into liquid and returned to flow down the tower along with the fresh liquid feed. The hydrogen gas leaving the top of the first stage towers and depleted in deuterium content is utilized in the CM&S NH_3 synthesis plant. The liquid leaving the base of the tower and more concentrated in deuterium content is fed back to the Stage 1 cells. Thus D_2O is trapped in the cells and becomes increasingly more concentrated in the electrolyte.

Entrained electrolyte in the generated hydrogen and oxygen gases and separated out in the condensers is evaporated in E1. The condensed vapor from E1 serves as liquid feed to the top of T2. The same catalytic exchange reaction takes place in T2 between the water vapor from the T2 reboiler and the hydrogen generated in the Stage 2 cells. The hydrogen leaving the top of T2 is sent to the base of the first stage towers. The electrolyte entrained in the generated cell gases is condensed out in the condensers and evaporated in E2. The condensed vapor from E2 serves as liquid feed to the top of T3. The catalytic reaction takes place increasing the deuterium concentration of the liquid fed to the Stage 3 cells. Electrolyte entrained in the generated Stage 3 gases is condensed out and evaporated in E3. The condensed vapors

App.A5.2

~~SECRET~~

~~SECRET~~

then serve as liquid feed to T4. The electrolyte entrained in the generated stage 4 gases is condensed out and piped to Tk5 from where it is fed to the secondary concentration plant.

Essentially the same operation is carried out in each stage. Water to feed the towers for the first stage is ordinary steam condensate. Water for the succeeding stages is obtained from the electrolyte entrained in the gases generated in the preceding stage. The hydrogen gas leaving the top of the 4th stage tower is fed to the base of the 3rd stage tower along with the cell gas from the Third Stage cells; similarly, the gas streams from the tops of the Third and Second Stage towers are fed respectively to the bases of the Second and First Stage towers. Although the equipment remains essentially the same, it becomes progressively smaller in each succeeding stage and the concentration of D₂O in the electrolyte becomes higher with each succeeding stage.

The oxygen generated in the cells is piped through condensers and through T5 (oxygen scrubber) to remove the entrained electrolyte. The liquid is returned to the process while the oxygen proceeds on to the CM&S smelter and the coke - NH₃ plants.

Secondary Concentration Plant.

The concentration of the material received from the Primary Plant is continued in the Secondary Plant. A batch process is used to bring the concentration from about 2.3% D₂O up to 99.8% D₂O in three stages consisting of 125, 21 and 4 electrolytic cells respectively. The Secondary Plant processes about 2140 lbs. of Primary

~~SECRET~~

~~SECRET~~

Plant product per day to recover the maximum heavy water concentrate and returns the remainder (about 2100 lbs. of the original feed) back to the Primary Plant.

The current production efficiency of the Secondary Plant is about 97 %.

The following is a brief description of the process flow for the Secondary Plant to accompany Figures 2 and 3. Table "B" gives a brief explanation of the various pieces of equipment.

The incoming product (2.2 to 2.4% heavy water) from the Primary Plant is fed into Tk-1 where it is mixed with KOH. When a suitable electrolyte (2.5% KOH) has been prepared, it is then charged into cells 1 through 125 where it is electrolyzed (or "rundown") to 1/7 the original volume. The gases ($H_2 + \frac{1}{2}O_2$) given off at the electrodes are sent through KOH dryers D-1a, b, c, d, and e, and then burnt to recombine the gases to form H_2O and condensed in BC-1. The water thus formed is returned to the Primary Plant since its concentration in heavy water (about 0.7% D_2O) is less than the incoming feed to Tk-1.

The concentrated rundown or residue from cells 1 through 125 is drained out, carbonated in sump tank Tk-2, and then evaporated to dryness in K-1. The vapor is condensed in C-1 and run into Tk-3 from where it is fed into cells 126 through 146. The K_2CO_3 sludge resultant of this evaporation is discarded.

App. A5.4

~~SECRET~~

~~SECRET~~

The material in cells 126 through 146 is electrolyzed to 1/7 its volume. The resultant gases are dried in D-2 and burned and condensed in BC-2. This burned gas condensate is then returned to Tk-1 or Tk-3 as feed for cells 1 through 125 or 126 through 146, depending on the concentration obtained as the electrolysis in cells 126 through 146 proceeds.

The concentrated residue from cells 126 through 146 is carbonated in sump tank Tk-4 and evaporated to dryness in K-1. The vapor is condensed in C-1 and ^{run} into Tk-5 from where it is fed into cells 147 through 150. The K_2CO_3 sludge is used to causticize the feed for cells 1 through 125.

The material in cells 147 through 150 is electrolyzed until the concentration of the burned gas condensate from BC-3 reaches 99.40% heavy water at which time the residue in the cells is at least product strength (99.8% heavy water). When this point is reached the electrolyte residue from cells 147 through 150 is drained, carbonated in sump tank Tk-6, and evaporated in K-2. The vapor is condensed in C-2 and the condensate is run into the product tank Tk-8 as material of a concentration of 99.8% D_2O . This material may undergo further distillation in a product still and blending to give a pure (low conductivity) product with a pH = 6.0 to 6.6 according to specifications.

The K_2CO_3 sludge from K-2 is used to causticize the feed for cells 126 through 146.

Product may also be obtained as the burned gas condensate from BC-3 by continuing the electrolysis in cells 147 through 150. However,

~~SECRET~~

~~SECRET~~

this presents disadvantages in that the elimination of nitrogen oxides from the burned gas is very difficult without an evaporation. Therefore it is more feasible to run the BC-3 gas condensate into Tk-3 or Tk-5 according to concentration from where it is fed to the cells.

The drainings from the KOH dryers (used for drying the electrolytic cell gases before burning) are utilized in causticizing the feed liquor to the respective cells.

The Primary Plant product is weighed into the Secondary Plant, while the final product and the return to the Primary Plant are also weighed. Thus all requirements for an overall plant chemical balance for heavy water are observed.

~~SECRET~~

~~SECRET~~

TABLE A

Explanatory notes on Equipment illustrated in Figure 1, Process Flow for Primary Concentration Plant:

<u>Equipment Piece</u>	<u>Remarks</u>
Feed Water Tank	2700 cu. ft. capacity
Catalytic Exchange Towers T1-A, B, C, T2, T3, T4	Each tower contains 13 exchange sections each comprising of two bubble cap plates (to obtain counter-current contact of liquid and vapor) and a catalyst bed (in which exchange reaction takes place). Besides the exchange sections each tower consists of a bottom section of bubble cap plates and a top section of boiling cap plates. T1-A, B, C, T2, and T3 use 1.11% Pt on charcoal base catalyst; and T4 uses 85% Ni - 15% Cr ₂ O ₃ catalyst. The towers vary in size as follows: T1-A, B, C = 111' 11 $\frac{1}{4}$ " high X 8' 6" I.D. T2 = 108' 4 $\frac{1}{4}$ " high X 5' I.D. T3 = 97' 10 $\frac{3}{8}$ " high X 2 $\frac{1}{2}$ ' I.D. T4 = 97' 1 $\frac{1}{2}$ " high X 1 $\frac{1}{2}$ ' I.D.
Reboilers R1-A, B, C, R2, R3, R4	Provided at base of each tower so that part of water in tower can be converted into vapor which is added to the gases rising through the tower. Reboilers are used to control humidity of gas phase in the towers.
Condensers C1-A, B, C, C2, C3, C4	Located at top of each exchange tower and used to condense out water vapor in off-gases.
Blowers B1-A, B, C, B2, B3, B4	Heavy duty, double lobed impellers, rotary gas pump used to boost hydrogen gas up through tower.
Gas Coolers (or Condensers):	Condense out entrained electrolyte from gases, H ₂ and O ₂ , generated from electrolytic cells. Conventional tube and shell type cooler.
Electrolytic Cells Stage 1	2687 diaphragm type cells, KOH and NaOH electrolyte, 15 to 21 electrodes per cell, 10,000 amps.

App. A6.7

~~SECRET~~

~~SECRET~~

<u>Equipment Piece</u>	<u>Remarks</u>
Stage 2	378 diaphragm type cells, KOH electrolyte, 15 electrodes per cell, 10,000 amps.
Stage 3	94 diaphragm type cells, KOH electrolyte, 15 electrodes per cell, 10,000 amps.
Stage 4	30 diaphragm type cells, KOH electrolyte, 15 electrodes per cell, 10,000 amps.
Tk-1	2504 cu. ft. capacity feed tank for Stage 1.
Tk-2	200 cu. ft. capacity feed tank for Stage 2.
Tk-3	50 cu. ft. capacity feed tank for Stage 3.
Tk-4	(includes two 33 cu. ft. capacity tanks) feed tank for Stage 4.
Tk-5	64 cu. ft. capacity tank for Stage 4 condensate (entrained electrolyte in generated H ₂ and O ₂ from Stage 4 cells and product of Primary Plant).
E1	Prepares feed water for T2 from electrolyte condensate from gas coolers for Stage 1 cells. Swenson single-effect calandria type evaporator designed to produce 550 gal. per hr. of distilled water from a feed of 687.5 gal. per hr. of 0.5% KOH solution.
E2 (includes one spare)	Prepares feed water for T3 from electrolyte condensate from gas coolers for Stage 2 cells. single-effect, calandria type evaporator. Capacity = 150 gals/hr of distilled water from feed of 187.5 gals/hr of 0.5% KOH solution.
E3	Prepares feed water for T4 from electrolyte condensate from gas coolers for Stage 3 cells. single-effect, calandria type evaporator. Capacity = 50 gals/hr of distilled water from feed of 62.5 gal/hr of 0.5% KOH solution.
T5	Oxygen scrubbing tower used to remove water vapor from the oxygen stream from cells. The condensate may be returned to

~~SECRET~~

~~SECRET~~

Equipment Piece

Remarks

T5 (continued)

the Stage 1 or 2 operation. Tower is 6' I.D. Cu cylindrical shell, 36' 11 3/8" overall length, and contains 20 bubble cap plates.

App. A5.9

~~SECRET~~

~~SECRET~~

TABLE B

Explanatory notes on equipment illustrated in Figure 2, Process Flow for Secondary Concentration Plant:

<u>Equip. No.</u> (See Att'd Drwg.)	<u>Remarks</u>
Tk-1	Feed preparation tank for cells 1 through 125. Has capacity of 8000 lbs. H ₂ O. Receives approximately 2140 lbs. water (2.2 to 2.4% D ₂ O) per day from the Primary Plant. To this about 53 lbs. KOH is added in preparing the electrolyte for cells 1 to 125.
Electrolytic Cells	1000-ampere cells with NI plated anodes and Fe cathodes. Nos. 1 through 125 are for the initial feed to the secondary plant and concentrate the water from about 2.3% D ₂ O to about 15% D ₂ O. Nos. 126 through 146 concentrate the water to 76% D ₂ O. Nos. 147 through 150 concentrate the water to 99.8% D ₂ O.
Tk-2	Sump tank and carbonator for residue from cells 1 to 125. Has a capacity of 1000 lbs. H ₂ O.
K-1	Horizontal, gas-fired evaporator for the carbonated residue (or rundown) from cells 1 through 146.
C-1	Condenser for K-1.
Tk-3	Feed tank for cells 126 through 146. Has capacity of 3600 lbs. H ₂ O.
Tk-4	Sump tank and carbonator for residue from cells 126 through 146. Has a capacity of 450 lbs. H ₂ O.
Tk-5	Feed tank for cells 147 through 150. Has a capacity of 900 lbs. H ₂ O.
Tk-6	Sump tank and carbonator for residue from cells 146 through 150. Has a capacity of 220 lbs. H ₂ O.
K2	Horizontal, gas-fired evaporator for the carbonated residue from cells 147 through 150.
C-2	Stainless Steel condenser for K-2.

App. A5.10

~~SECRET~~

~~SECRET~~

<u>Equip. No.</u> <u>(See Att'd Drwg.)</u>	<u>Remarks</u>
Tk-8	Product storage tank. Has a capacity of 1000 lbs. H ₂ O.
D-1 a, b, c, d, e	Gas dryers for gaseous mixture H ₂ + $\frac{1}{2}$ O ₂ from cells 1 through 125. Packed with solid KOH.
BC-1	Gas burner and condenser for H ₂ + $\frac{1}{2}$ O ₂ mixture from cells 1 to 125. Excess O ₂ is supplied for flushing the burners and eliminating nitrogen oxides from burned gas.
Tk-7	Sump tank for burned gas condensate from BC-1. Has a capacity of 4000 lbs. H ₂ O. Receives about 2000 lbs. H ₂ O (0.7% D ₂ O) from BC-1 per day which is returned to the Primary Plant.
D-2	Gas dryers for H ₂ + $\frac{1}{2}$ O ₂ from cells 126 through 146. Packed with solid KOH.
BC-2	Gas burner and condenser for H ₂ + O ₂ mixture from cells 126 through 146. Condensate from BC-2 is fed into Tk-1 from where it is charged to cells 1 through 125.
D-3	Gas dryer for H ₂ + $\frac{1}{2}$ O ₂ from cells 147 through 150. Packed with solid KOH.
BC-3	2 gas burners and condensers of stainless steel construction for H ₂ + $\frac{1}{2}$ O ₂ mixture from cells 147 through 150. Condensate from BC-3 is fed into Tk-3 from where it is charged to cells 126 through 146.

App. A5.11

~~SECRET~~

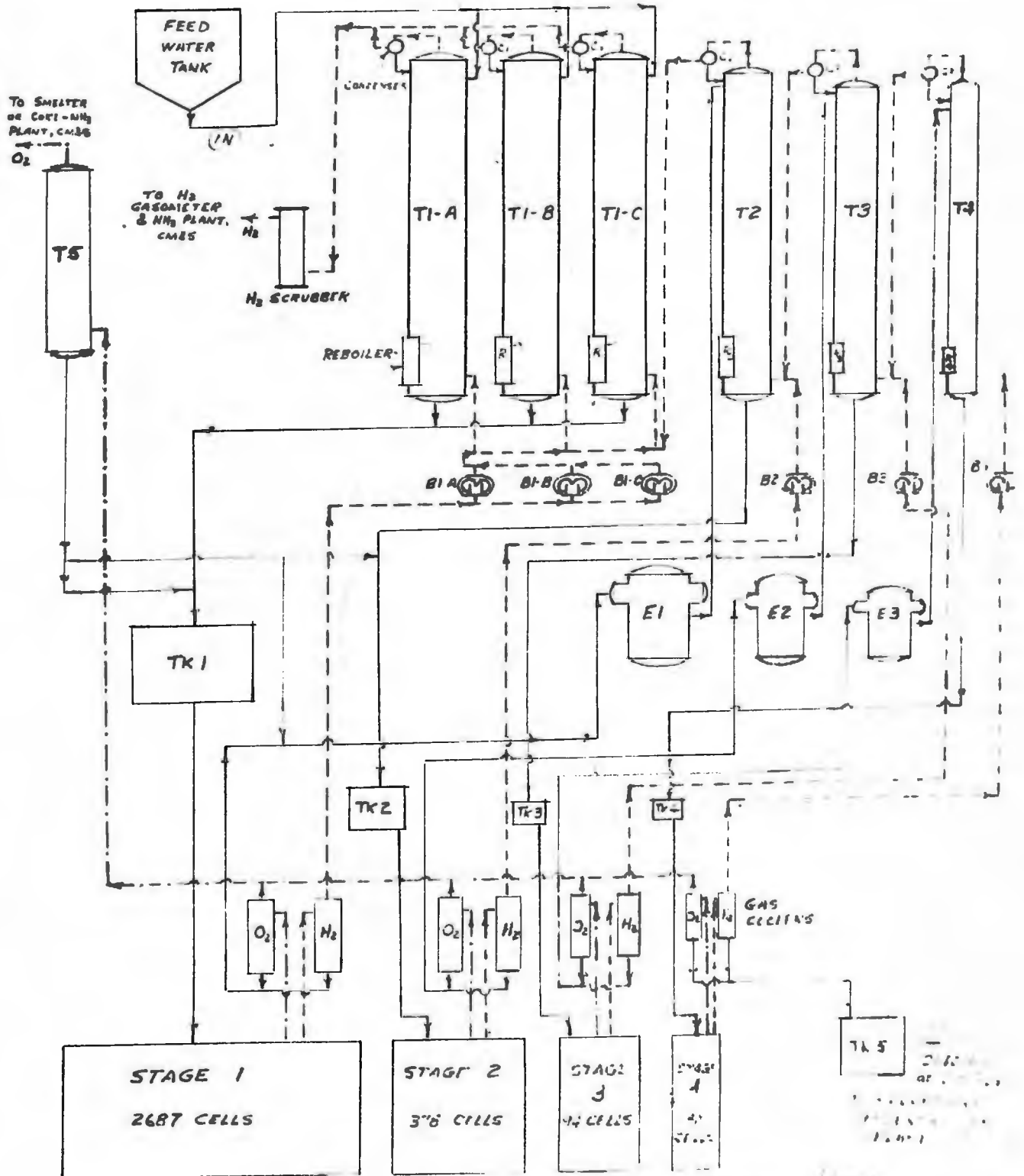

— LIQUID FLOW
 - - - HYDROGEN FLOW
 ···· OXYGEN FLOW

App. No. 22

1. ...
 2. ...
 3. ...
 4. ...
 5. ...

App. A5.13

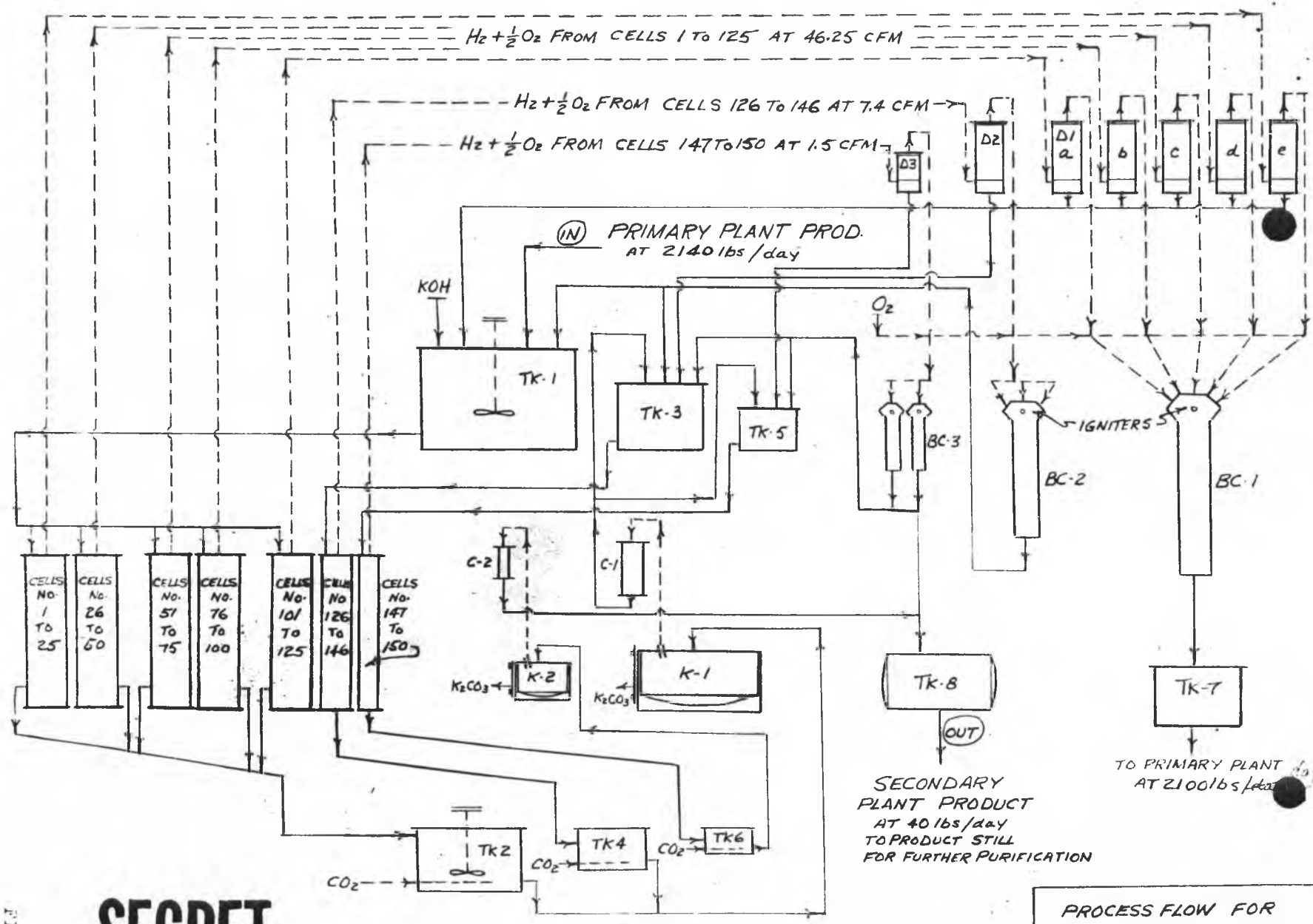

FIG. 2

SECRET

LIQUID FLOW
INDICATED BY ARROWS

PROCESS FLOW FOR
SECONDARY CONCENTRATION
PLANT
CM&S HEAVY WATER OPR.

~~SECRET~~

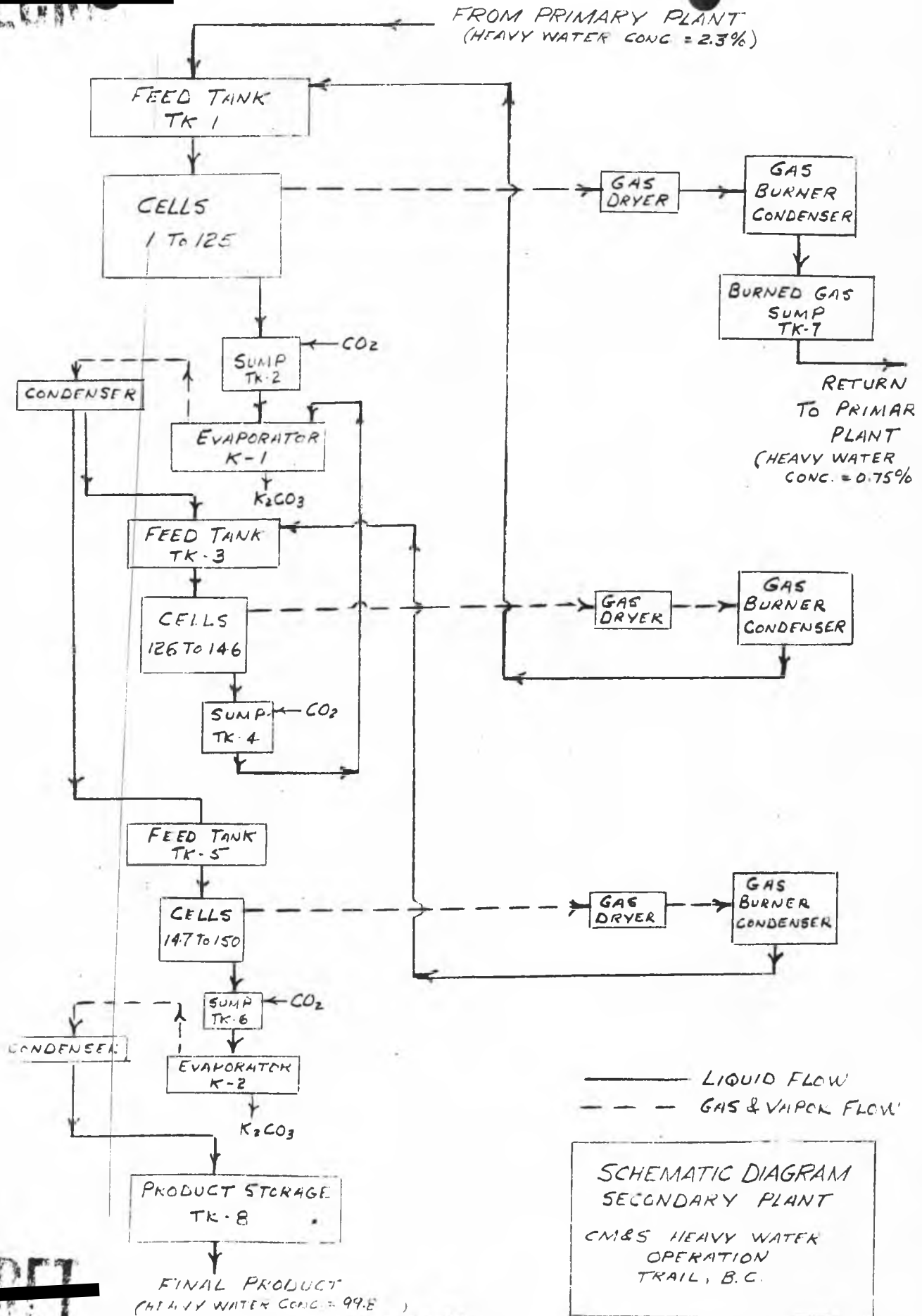

~~SECRET~~

~~SECRET~~

APPENDIX A6

DESCRIPTION OF THE DU PONT HEAVY WATER DISTILLATION PLANTS

Du Pont plants located at the Morgantown, Alabama and Wabash River Ordnance Works provide for the separation of heavy water by continuous vacuum distillation. The equipment at each of the sites differs only in size, each plant consisting essentially of an eight-stage continuous distillation train in which ordinary water is stripped from the slightly less volatile heavy water. The distillation plants concentrate the water to about 90% D₂O. The remaining separation takes place in the du Pont Finishing Plant at Morgantown by electrolysis (See App. A7).

The following is a brief description of the process flow for the distillation plant to accompany Figure I. Table A gives a brief explanation of the various pieces of equipment.

The first stage of the distillation train consists of a series of towers arranged in parallel in groups of five, one group at Morgantown Ordnance Works, two at Alabama Ordnance Works, and three at Wabash River Ordnance Works. The feed to the distillation train is steam condensate from the calandrias of the first stage columns, and enters the system at the top of the 15' diameter towers in the first stage units. The condensate passes down through the tower and undergoes a vacuum distillation wherein the less volatile heavy water content becomes more concentrated in the liquid as it passes

App. A6.1

~~SECRET~~

~~SECRET~~

down through the towers while the vapor depleted in heavy water passes up and out the top of the towers. This vapor from the tops of the first stage units is condensed in barometric condensers and discarded (except at Morgantown Ordnance Works where it is used as make-up for the cooling water to the condensers).

The concentrated material from the bottoms of each of four of the groups of five first stage units, which are designated as straight away units, is drawn off at a predetermined rate and pumped into the line leading from the fifth unit (which is designated as the circulation unit). The concentrated material from the bottom of the circulating unit and the straight away units is fed to the top of a single second stage unit at a rate approximately equal to the boilup of the latter. Distillate from the second stage unit is returned near the bottom of the first stage circulating unit at a point in the column having the same concentration.

An alternative method of feeding the Second Stage Units with the First Stage tower concentrate is to feed the concentrated material from the bottoms of each first stage unit directly to the top of the second stage unit and distillate from the second stage is returned directly near the bottom of each first stage unit. In this latter alternative each first stage unit is termed a circulatory unit (See Fig. 2). Wabash River Ordnance Works at present employs this method successfully.

App. A6.2

~~SECRET~~

~~SECRET~~

The liquid leaving the bottom of the second stage is concentrated to such an extent that it is necessary to put it through an evaporation step for the removal of dissolved solids. Condensate from the evaporators is fed to the top of the third stage column.

The third and succeeding stages at each site are single columns whose sizes are determined by the number of first stage units at the site, and at any given site the columns are progressively smaller as the concentration of heavy water increases through the system. In every stage the system is essentially the same: feed to the stage is liquid from the base of the preceding stage and the vapor from the top of the stage is condensed and returns to near the bottom of the preceding stage.

The product from the eighth stage is pumped to a draw-off can especially designed for this purpose, at scheduled intervals and quantities. A final evaporator is provided for removal of any solids remaining in the product.

App. A6.3

~~SECRET~~

~~SECRET~~

TABLE A

Explanatory Notes on Equipment illustrated in Figure I.
Process Flow for Distillation Train;

<u>Equipment Piece</u>	<u>Remarks</u>
A. <u>First Stage:</u>	Several Units in parallel make up first stage at each site. Units are headered in groups of five, each group supplying a second stage unit. There are 15 Units at Wabash River Ordnance Works, 10 at Alabama Ordnance Works, and 5 at Morgantown Ordnance Works.
(1) Tower:	Each first stage unit tower is in two sections so connected in series as to function as a single fractionating column. The top, or feed, section is 15 feet diameter X 100 feet high, and contains 80 tunnel cap plates. The bottom section is 12 feet diameter X 106 feet high, and contains 90 bubble cap plates.
(2) Calandrias:	Attached at bottom of 12 ft. section. Construction is of conventional shell and tube type.
(3) Condenser:	Each unit has a barometric condenser and a two-stage steam jet vacuum pump with barometric inter-condenser.
(4) Pumps:	All pumps in duplicate to insure operating continuity. Pumps used to transfer steam condensate from calandria, thru coolers, to top of 15 ft. tower section; to transfer liquid from bottom of 15 ft. to top of the 12 ft. section; to take liquid from base of 12 ft. section and deliver it to the second stage feed header.
(5) Feed Coolers:	(Not illustrated in Process Flow Diagram) Drip coolers provided to cool steam condensate from the calandria to the correct feed temperature.

App. A6.4

~~SECRET~~

<u>Equipment Piece</u>	<u>Remarks</u>
B. <u>Second Stage</u>	One Second Stage Unit provided for each group of five first stage units.
(1) Tower:	Each Second Stage Unit is in two series sections functioning as a single column. Top section is 10½ ft. diameter X 83 ft. 7½ in. high, and contains 72 bubble cap plates. The bottom section is 8 ft. diameter X 92 ft. 10½ in. high, and contains 83 bubble cap plates.
(2) Calandria:	Conventional shell and tube type attached to bottom of 8 ft. column.
(3) Condenser:	Conventional shell and tube, water cooled condenser used on each Second Stage Unit. These condensers are of "falling film" type. In addition to the main condenser, two NH ₃ -cooled condensers are provided to reduce vapor losses to a minimum.
(4) Evaporators:	Used to remove solid impurities from feed to Third Stage. Four parallel evaporator units are provided at Wabash River Ordnance Works, three at Alabama Ordnance Works, and two at Morgantown Ordnance Works. A condenser is provided for each evaporator with a single set of refrigerated vent condensers for the group. The evaporators are of such size that the total evaporation load at any site can be handled with one evaporator out of service.
C. <u>Third Stage</u>	Third Stage at each site is a single conventional bubble cap tower, with the usual auxiliaries.
(1) Tower:	All towers have 71 active bubble cap plates and one spray catching plate. Tower diameters vary at different sites as follows: 5½ ft. diameter at Wabash River Ordnance Works 4½ ft. diameter at Alabama Ordnance Works 3½ ft. diameter at Morgantown Ordnance Works

~~SECRET~~

<u>Equipment Piece</u>	<u>Remarks</u>
(2) Calandrias:	shell and tube, steam heated, similar in type to those on previous stages.
(3) Condensers:	essentially similar to system used on stage two.
D. <u>Fourth, Fifth, Sixth, Seventh & Eighth Stages:</u>	essentially similar in arrangement with that of stage three. Sizes vary as follows:
(1) Fourth Stage Tower:	2½ ft. diameter and 72 bubble cap plates at Wabash River Ordnance Works; 2 ft. diameter and 72 plates at Alabama Ordnance Works; and 1½ ft. diameter and packed with 5/8" X 5/8" ceramic rings at Morgantown Ordnance Works.
(2) Fifth, Sixth, Seventh and Eighth:	1½ ft. diameter X 72 ft. high, packed, at Wabash River Ordnance Works; 16" diameter X 72' high, packed, at Alabama Ordnance Works; and 10" diameter X 72' high, packed, at Morgantown Ordnance Works.
E. <u>Final Evaporator:</u>	Patterson steam jacketed kettle, for removal of solid impurities from distillation train product.

~~SECRET~~

Steam Ejector
Barometric Condenser

PROCESS FLOW-178 BUILDING-First Stages on Straightaway, Except "E" Unit.

65-150 mm. Hg.

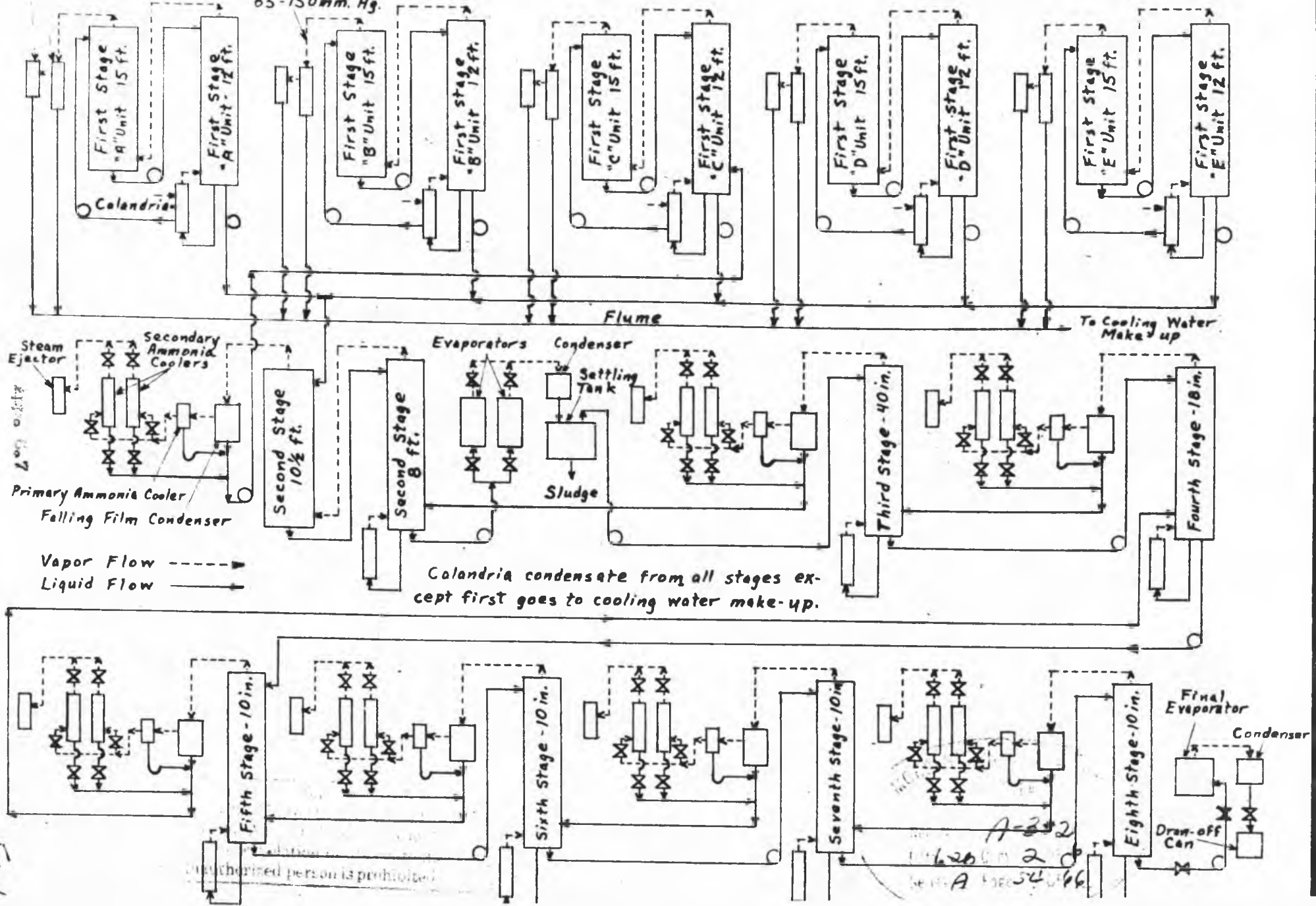

Colandria condensate from all stages except first goes to cooling water make-up.

FIG 1

Unauthorized person is prohibited

PROCESS FLOW-178 BUILDING-First Stages as Circulating Units

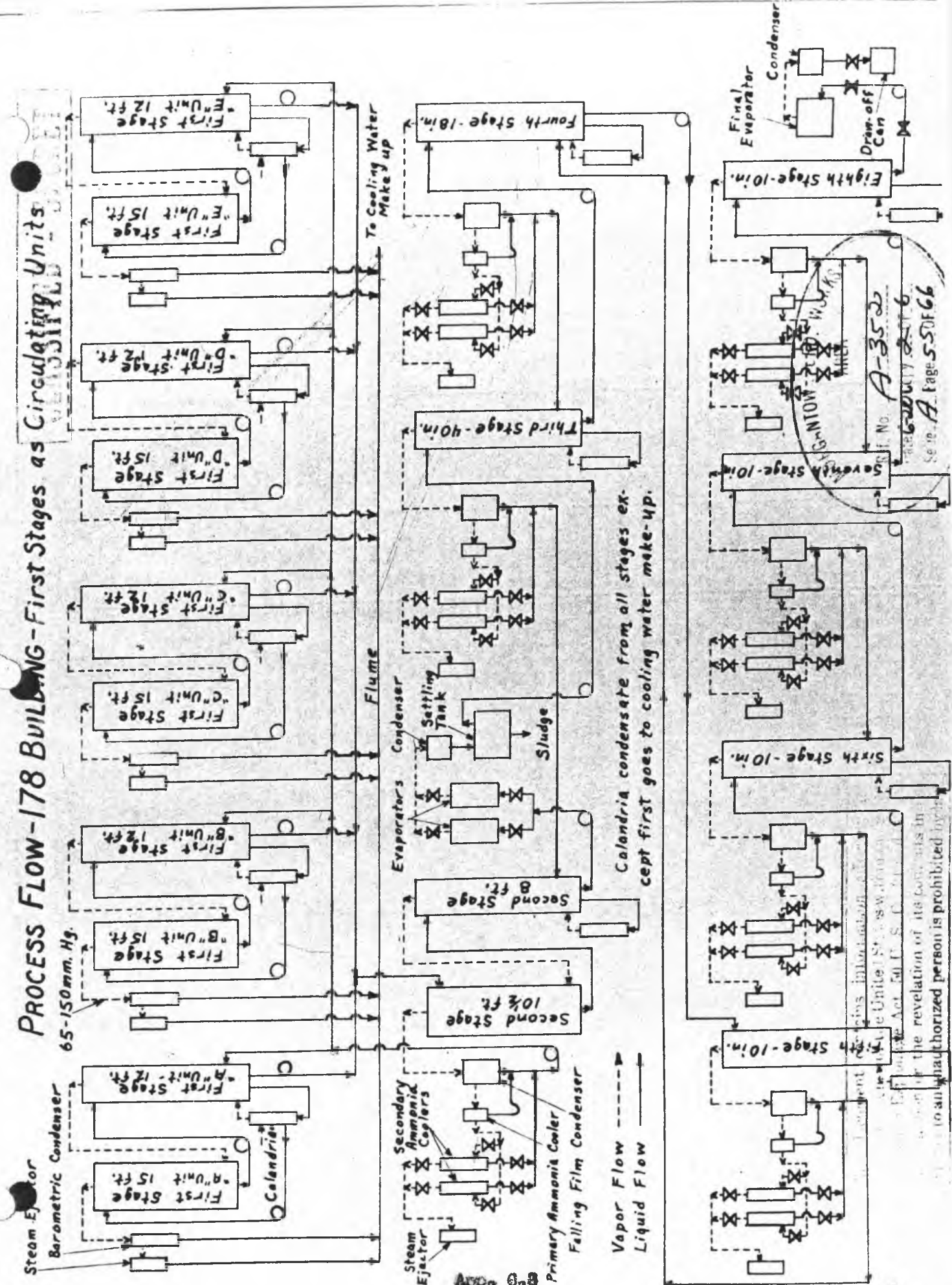

FIG. 2

~~SECRET~~

APPENDIX A7

DESCRIPTION OF THE DU PONT HEAVY WATER FINISHING PLANT

The du Pont Heavy Water Finishing Plant was designed to process 9600 lbs (1150 gal.) of material containing 50% Heavy Water per month. The present operations call for the processing of 2300 to 2400 lbs. of 90% heavy water per month. The current production efficiency of the Finishing Plant ranges between 96 and 98%.

The following is a brief description of the process flow for the Finishing Plant to accompany Figures 1 and 2. Table "A" describes the various pieces of equipment.

The incoming product (90% heavy water) from the 8th stage tower of the distillation train is fed into Tk-1 from where it is pumped to Tk-2, the head tank for the initial evaporation in the Dopp Kettle, K-1. The vapor from K-1 is condensed in C-1 and the condensate is moved to Tk-3 where it is mixed with K_2CO_3 to form the electrolyte (7-1/2% by wt K_2CO_3) for cells 33 to 48. The gases ($2H_2 + O_2$) from the cell electrodes pass through the liquid-gas separators S-1 and S-2 and the NH_3 coolers. The gaseous mixture is then burned in excess O_2 . (to recombine H_2 and O_2 to give H_2O) and condensed in C-3. The condensate from the burned gases is then moved to the cut tanks where it is held according to concentration (See Cut tanks, Table A). Before the condensate is added to the cut tanks, 20% K_2CO_3 is added in order to neutralize any acid (eg HNO_3 formed by oxidation of any of N_2 which might be present) and thus prevent corrosion in cut tanks.

App. A7.1

~~SECRET~~

~~SECRET~~

After the concentration of the condensate from the burned gases reaches 99.4% heavy water (at which time the cell residue is at least 99.8% heavy water), the cell residue from cells 33 to 48 is drawn off into Tk-4 from where it is pumped to K-2, by way of Tk-5, for final evaporation. The K-2 vapor is condensed in C-2 and the condensate cooled. At this point a conductivity control test is made, and if the conductivity is within limits, the liquid is dropped into the product tanks.

The liquid from the liquid-gas separators, S-1 through 4, and the liquid from the explosion traps, Tks 13 & 14, are added to the carbonate mixing tank Tk-9, or to the cut tanks, by way of Tk-8. The electrolyte for cells 11 to 32 is prepared in Tk-9 and, prior to the K_2CO_3 mixing, ranges in concentration from 5 to 80% heavy water. The gases from cells 11 to 32 are separated from liquid entrainment (S-3 & S-4), cooled, burned and condensed (C-4) in the same manner as are the more concentrated gases from cells 33 to 48. The condensate from C-4 is neutralized with K_2CO_3 and placed in the cut tanks according to concentration.

The cut tanks feed the electrolyte cells by way of the carbonate mixing Tks 3 and 9. Tks 7b through 7f are used for cells 11 to 32. Tks 7g and 7h are used for cells 33 to 48. Tk 7a is used to store material of concentration less than 5% which to date has not undergone further treatment.

App. A7.2

~~SECRET~~

~~SECRET~~

TABLE A

Explanatory notes on Equipment illustrated in Figure No. 1, Process Flow Diagram of Finishing Plant:

<u>Equip. No.</u>	<u>Remarks</u>
Tk-1	20-gal. hold tank from which feed is pumped to K-1 head tank. Necessary inasmuch as distillation train product container could not withstand pressure resultant of this pumping operation direct from the container.
Tk-2	100-gal. head tank for K-1.
K-1	50-gal. Dopp Kettle for initial evaporation to eliminate solid impurities which are discharged to sewer.
C-1	Condenser for K-1. Consists of Stainless Steel coil immersed in cooling water.
Tk-3	200-gal. K_2CO_3 mixing tank used to prepare electrolyte for cells 33 to 48.
Tk-9	150-gal. K_2CO_3 mixing tank used to prepare electrolyte for cells 11 to 32.
Electrolytic Cells	Capacity per cell is 15 gal. Each cell comprised of a Ni anode and Fe cathode. Cells 11 to 32 are used for concentrations less than 80% heavy water (22 cells now in opr.) and cells 33 to 48 are used for concentrations greater than 80% heavy water (10 cells in opr.) Cells 49 to 64 are fed with normal water and serve as a ballast to maintain or exceed the minimum load requirements on the rectifier.
Tk-4	300-gal. cell residue receiver for final product concentrations.
Tk-5	350-gal. head tank for final evaporation. Tk-5 was previously used as a carbonating tank when KOH was used as the electrolyte.
K-2	30 gal. Dopp Kettle evaporator.

App. A73

~~SECRET~~

~~SECRET~~

<u>Equip. No.</u> (See Att'd Drwg.)	<u>Remarks</u>
C-2	Condenser for K-2. Is backward return type (i.e. Condensate leaves condenser at boiling temp.)
Conductivity Cell	Used to check purity of final distillate wherein conductivity is indicative of product contamination.
Tks. 6a, 6b	100 gal. stainless steel product tanks. N ₂ blown into tanks to sweep out CO ₂ and thus reach pH specifications (pH specifications for product = 6.0 to 6.6)
S-1	Liquid-gas separator before NH ₃ cooler (cells 33 to 48)
S-2	Liquid-gas separator after NH ₃ cooler (cells 33 to 48)
S-3	Liquid-gas separator before NH ₃ cooler (cells 11 to 32)
S-4	Liquid-gas separator after NH ₃ cooler (cells 11 to 32)
Igniters	Gases (2H ₂ + O ₂) are burned with slight excess O ₂ to give H ₂ O).
C-3	Condenser for ignited gases from cells 33 to 48.
C-4	Condenser for ignited gases from cells 11 to 32.
Cut Tks 7a to 7h	Used to hold water of varying concentrations which must undergo further electrolysis (exception 7a) (7a) 800-gal. tk. for conc. of 0 to 5% and used to store water which does not warrant further process at present time. (7b) 300-gal. tk for conc. 5 to 10% (7c) 300-gal. tk for conc. 10 to 20% (7d) 150-gal. tk for conc. 20 to 40% (7e) 150-gal. tk for conc. 40 to 60% (7f) 100-gal. tk for conc. 60 to 80% (7g) 100-gal. tk for conc. 80 to 95% (7h) 100-gal. tk for conc. 95 to 99.4%

App. A7.4

~~SECRET~~

Equip. No.
(See Att'd Drwg.)

Remarks

Tk-8	50-gal. cell header drainage tank. From Tk-8 the material moves to the cut tanks.
Tks. 11, 12	50-gal. hold tanks for liquid from liquid-gas separators S-1, S-2, S-3, S-4. From Tks 11 and 12 the liquids move to the cut tanks via Tk-8.
Tks. 13, 14	75-gal. tanks which serve as explosion traps. Liquid collected in these traps moves to out tanks.
Tk. 10	350-gal. auxiliary storage tank.

~~SECRET~~

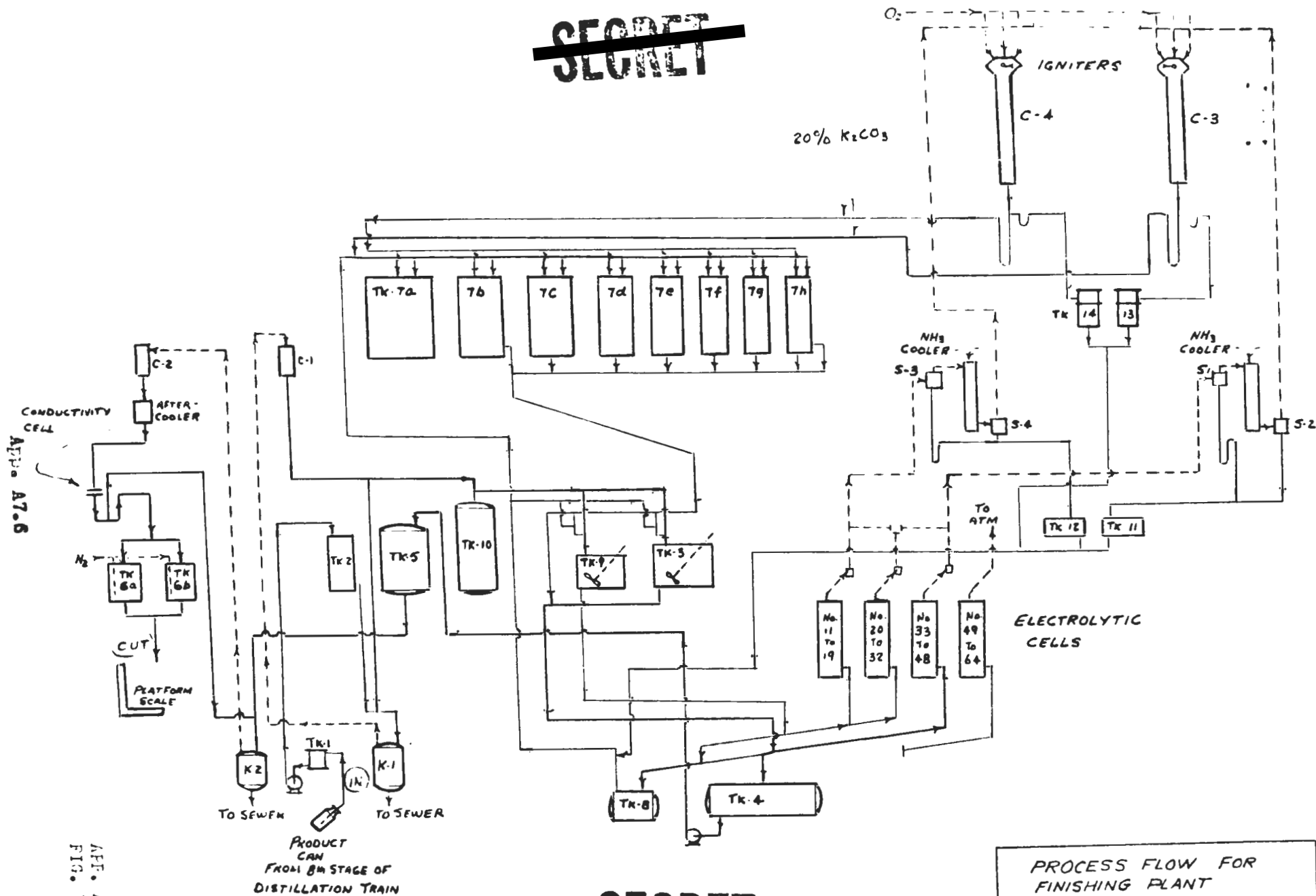

APP. # 7.6
FIG. I

PROCESS FLOW FOR
FINISHING PLANT
DUPONT P-9 OPERATION

~~SECRET~~

~~SECRET~~

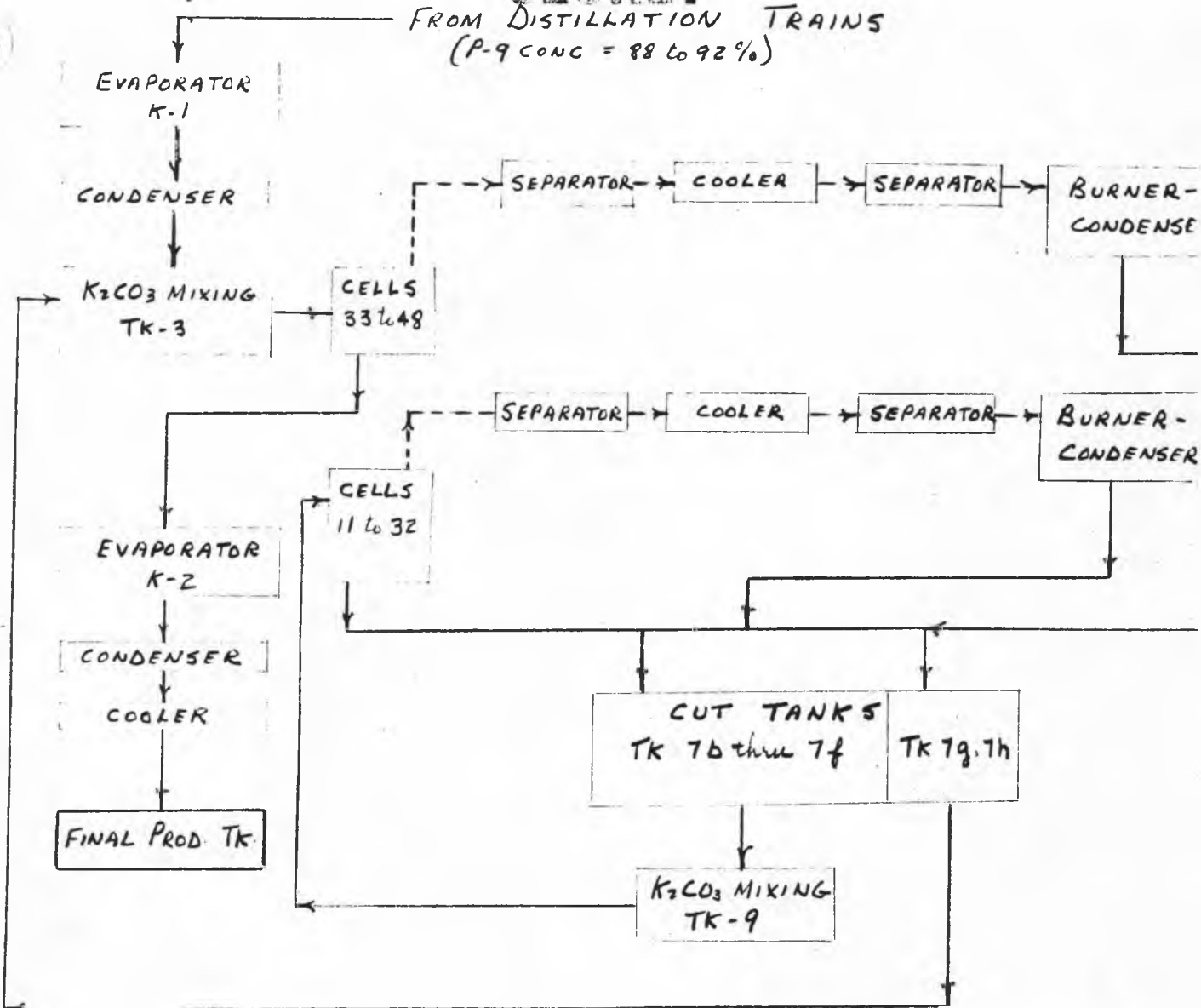

———— LIQUID OR VAPOR, H₂O
- - - - GAS, H₂ + O₂

SCHMATIC DIAGRAM
FINISHING PLANT
DuPont P-9 OPERATION
MOW

~~SECRET~~

APP. 87.7

AFI. A 7.7
FIG. 2

~~SECRET~~

APPENDIX B

PHOTOGRAPHS

- B1. Trail Plant
(B1-1 to B1-29 inclusive, 17 pages)
- B2. Plant at Morgantown Ordnance Works
(B2-1 to B2-9 inclusive, 9 pages)
- B3. Plant at Wabash River Ordnance Works
(B3-1 to B3-5 inclusive, 5 pages)
- B4. Plant at Alabama Ordnance Works
(B4-1 to B4-14 inclusive, 7 pages)

App. B

~~SECRET~~

~~SECRET~~

B1-1 Booster Room From West (8 November 1943)

B1-2 Booster Room Operating Panel From East
(8 November 1943)

App B1.1

~~SECRET~~

~~SECRET~~

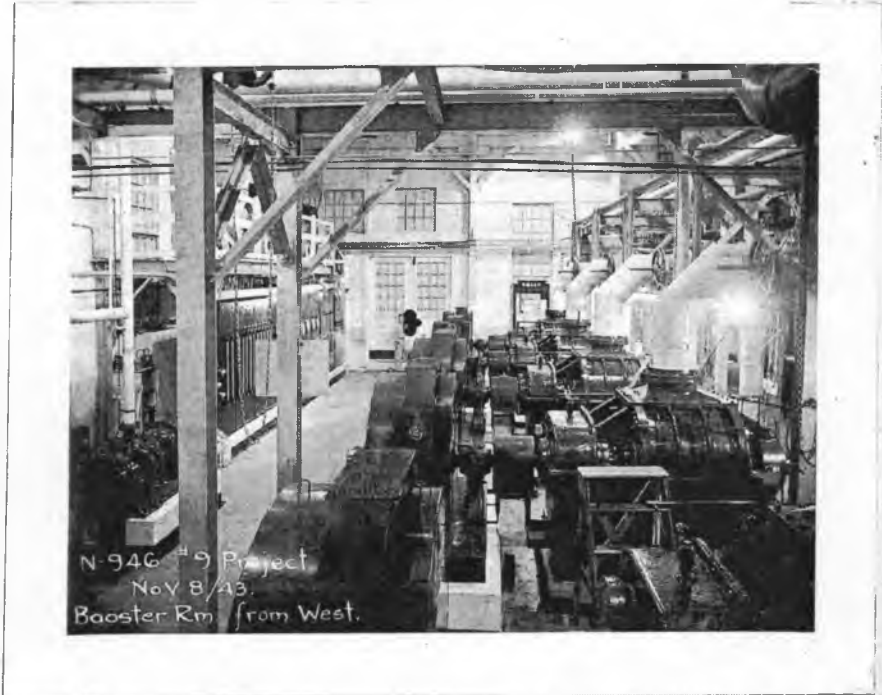

N 946 #9 Project
Nov 8/43
Booster Rm from West.

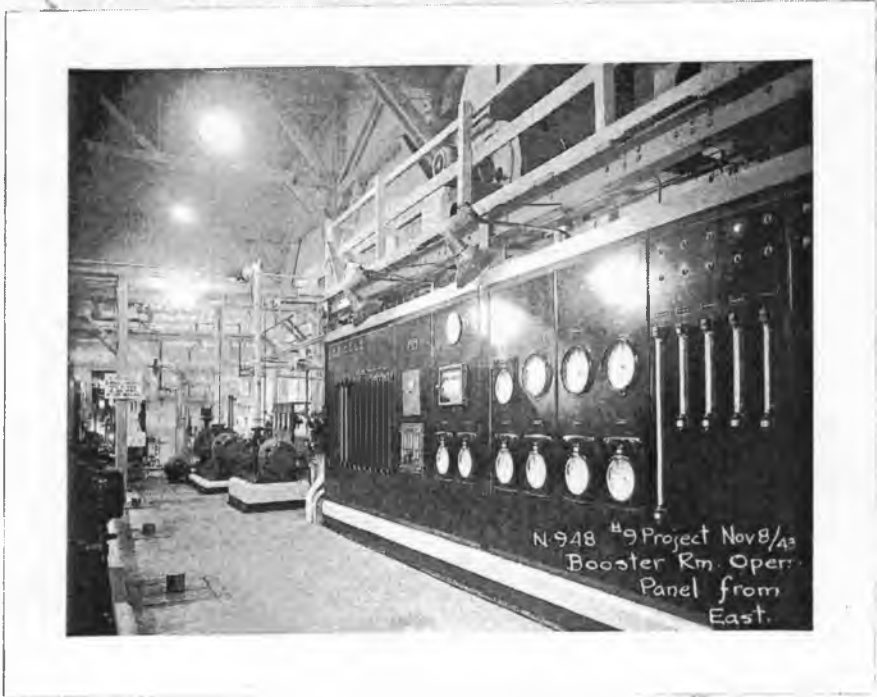

N 948 #9 Project Nov 8/43
Booster Rm. Oper.
Panel from
East.

~~SECRET~~

~~SECRET~~

B1-3 Pumps in Evaporator Building (15 April 1943)

B1-4 Primary Plant Evaporator Room from S. W. (13 Nov. 1943)

App. B1.2

~~SECRET~~

~~SECRET~~



Fig. 1
Exhaustor room



1953 Nov 13/1943
W-9 Project Primary
Plant Temperature Room
from SW

~~SECRET~~

~~SECRET~~

B1-6 Primary Plant Evaporator Room from N. E. (13 Nov. 1943)

App. B1.3

~~SECRET~~

~~SECRET~~

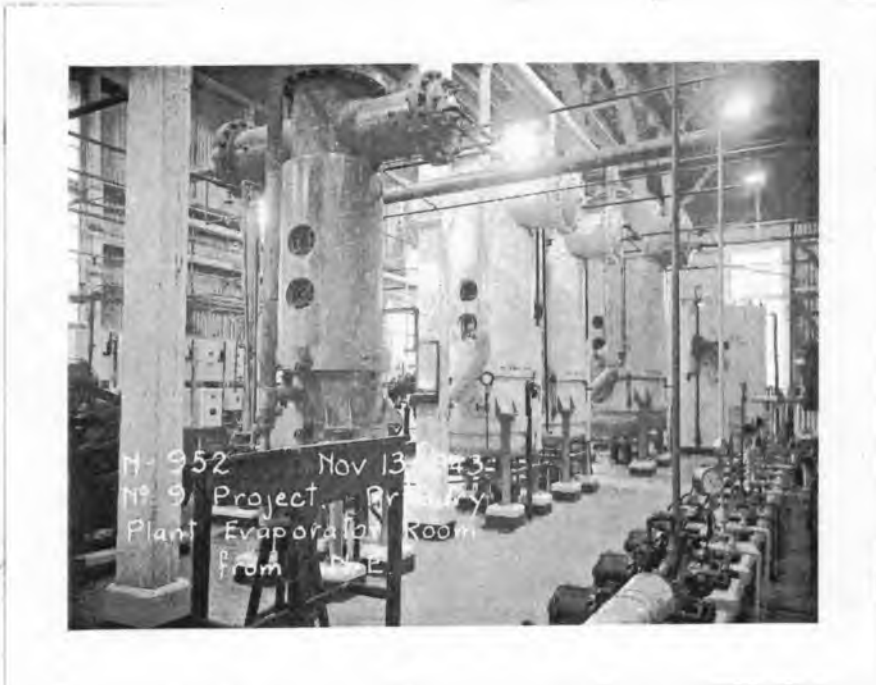

M-952 Nov 13 1953
No. 9 Project Priority
Plant Evaporation Room
from

~~SECRET~~

~~SECRET~~

31-6 Primary Towers from South (13 October 1943)

31-7 Primary Towers from North (13 October 1943)

App. 31.4

~~SECRET~~

~~SECRET~~

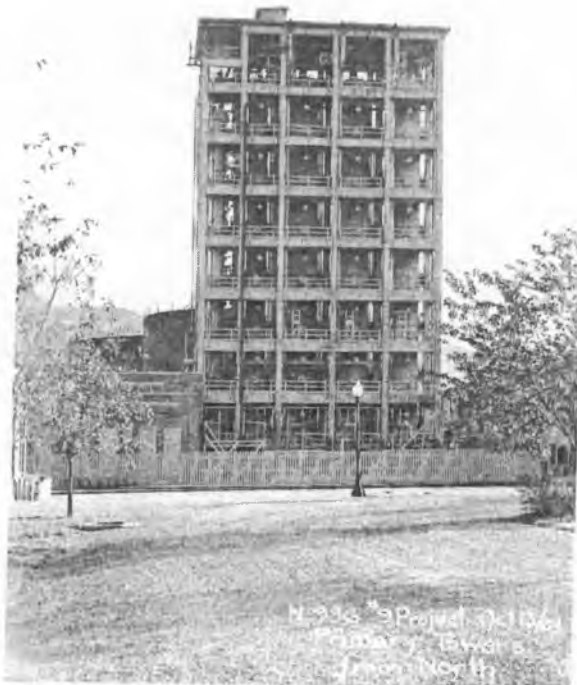
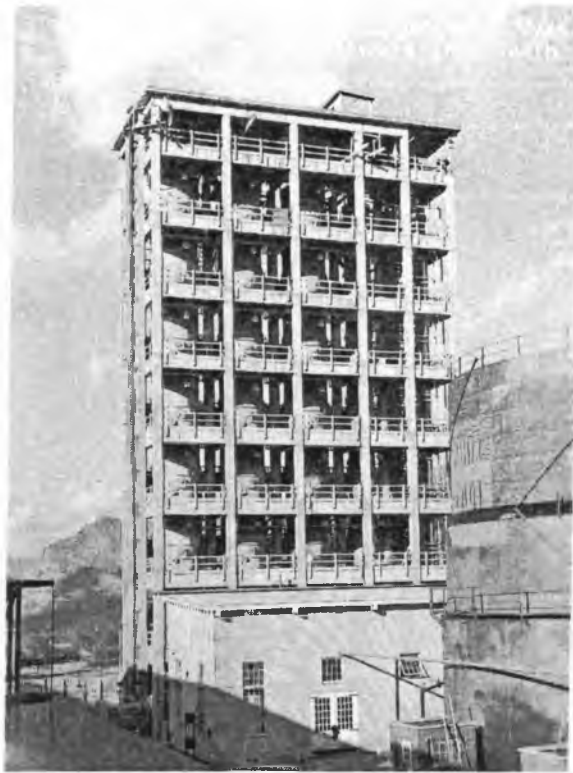

H-336 3rd Floor Oct 1964
Primary Elevation
1st Floor North

~~SECRET~~

~~SECRET~~

B1-8 Exchange Towers - Ground Floor - South Side from East
(13 October 1943)

App. B1.5

~~SECRET~~

~~SECRET~~
SECRET



Project Oct. 13/43
Towers - Ground
North side, from East.

~~SECRET~~
SECRET

~~SECRET~~

B 1-9 Exchange Towers - North Side from West (13 October 1943)

B1-10 Exchange Towers - North Side - 3rd Floor from West
(13 October 1943)

App. 31.6

~~SECRET~~

~~SECRET~~



N-939 'S Project Oct 13/43
Exchange Towers
North Side from West.



N-940 'S Project Oct 13/43
Exchange Towers - North
Side - 1st floor from

~~SECRET~~

~~SECRET~~

Bl-11 Exchange Towers - North Side - 5th Floor from East
(13 October 1943)

Bl-12 Exchange Towers - North Side - Top Floor from East
(13 October 1943)

App. Bl.7

~~SECRET~~

~~SECRET~~

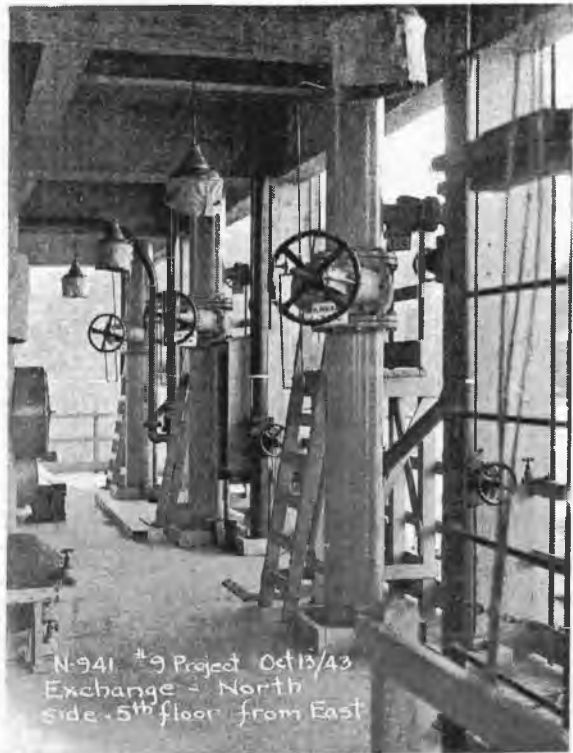

N-941 #9 Project Oct 13/43
Exchange - North
Side - 5th floor from East

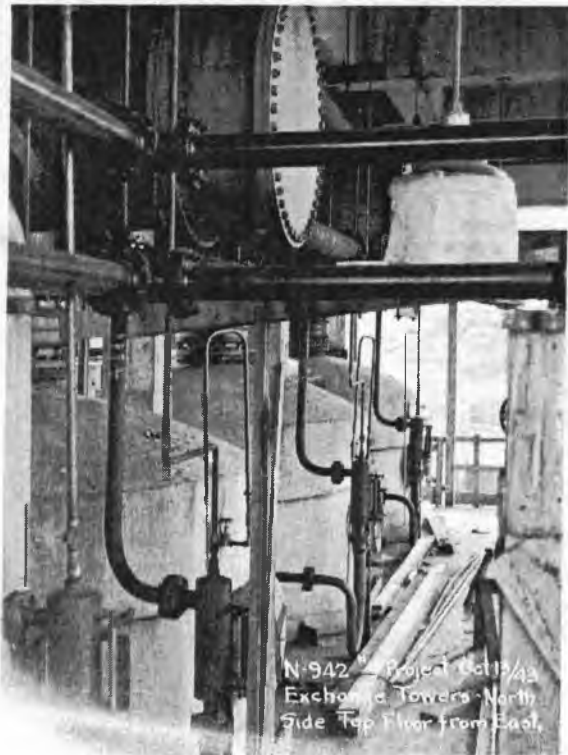

N-942 Project Oct 13/43
Exchange Towers - North
Side Top Floor from East

~~SECRET~~

~~SECRET~~

81-13 Exchange Tower Condenser - South Side from East
(13 October 1943)

81-14 Primary Tower 2nd Floor - South Side from West
(13 October 1943)

App. 81.8

~~SECRET~~



~~SECRET~~

Bl-15 General Exterior from H. W.
(8 November 1943)

~~SECRET~~

App. Bl.9

~~SECRET~~



~~SECRET~~

~~SECRET~~

**Bl-16 Secondary Plant Generator Room from N. E.
(8 November 1943)**

**Bl-17 Secondary Cell Room from N. W.
(8 November 1943)**

~~SECRET~~

App. Bl.10

~~SECRET~~

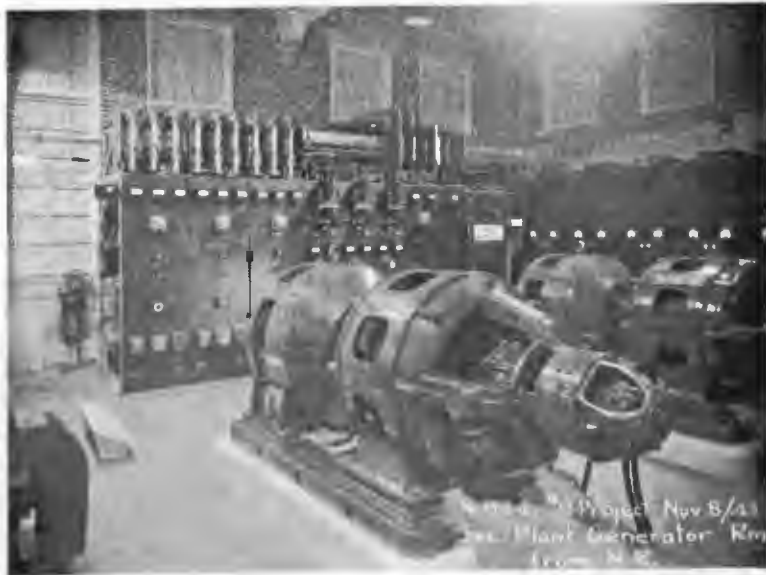

N-946 Project Nov 8/43
Gen. Plant Generator Rm
from N.E.



N-947
Project Nov 8/43
Secondary Cell Rm
from North.

~~SECRET~~

~~SECRET~~

B1-18 Secondary Cell Room from S. W.
(8 November 1943)

B1-19 Marley Cooling Tower from M. W.
(19 May 1943)

App. B1.11

~~SECRET~~

~~SECRET~~



~~SECRET~~

~~SECRET~~

Bl-20 Float in Dole's Continuous Analyser
(13 February 1943)

App. Bl.12

~~SECRET~~

~~SECRET~~

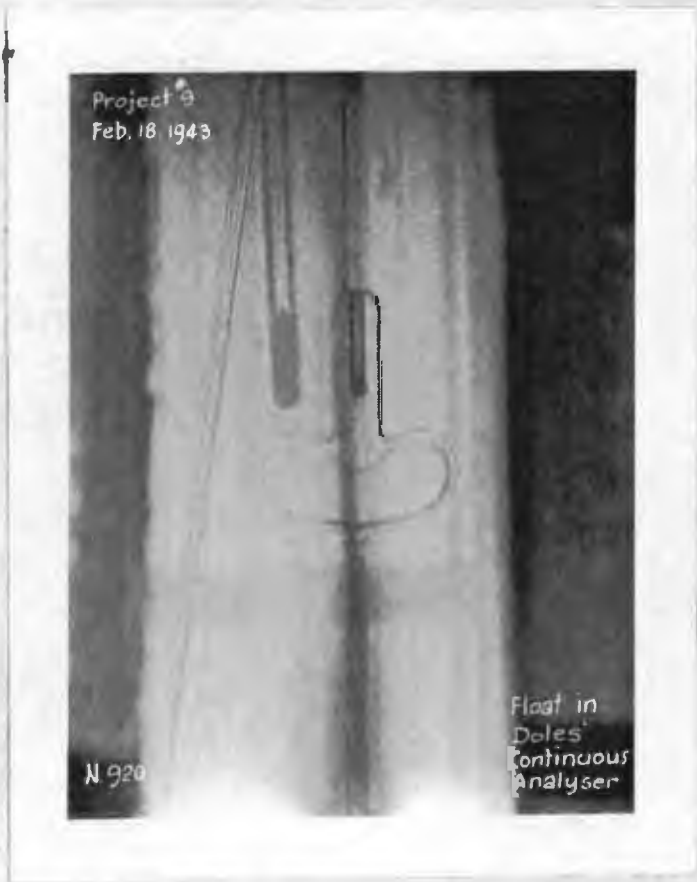

~~SECRET~~

~~SECRET~~

B1-21 Float - Dole Apparatus
(10 January 1944)

B1-22 Tungsten Decomposition Apparatus
(10 January 1944)

App. B1.13

~~SECRET~~

~~SECRET~~

N-960
Project 9

Jan. 10/44
Float-Dole Apparatus

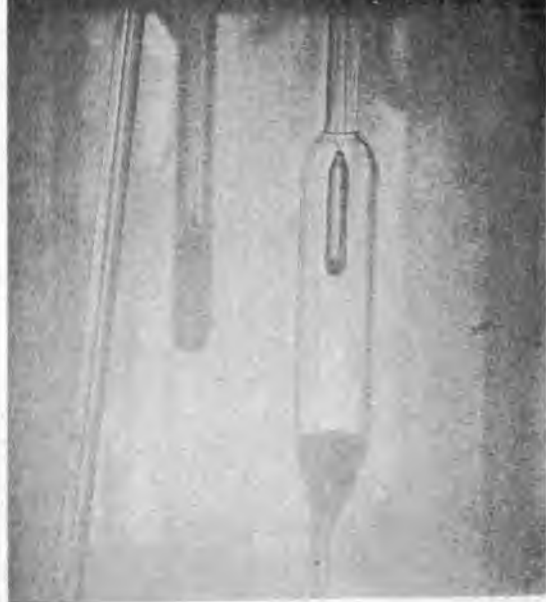

N-955
Project 9
Tungsten Decomposition Apparatus



~~SECRET~~

~~SECRET~~

B1-23 Dole Apparatus
(10 January 1944)

B1-24 Electrolytic Apparatus for Preparation of 100% P-9
(10 January 1944)

App. B1.14

~~SECRET~~

~~SECRET~~

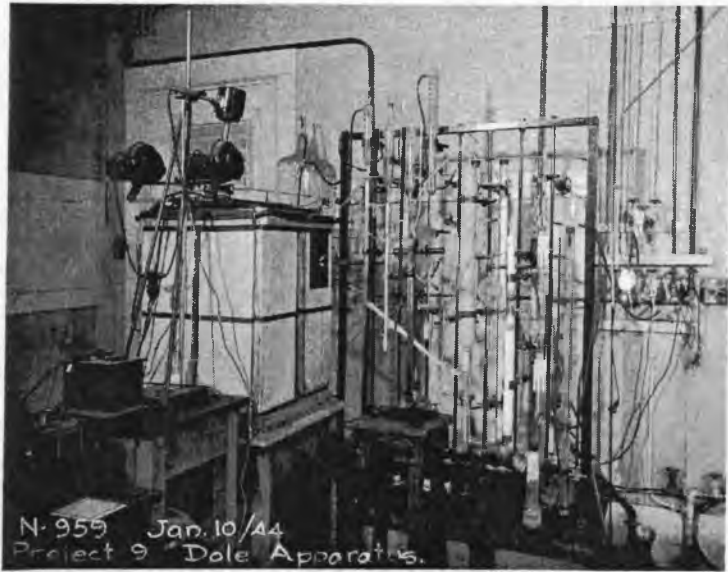

N-955 Jan. 10/44
Project 9 "Dole Apparatus."

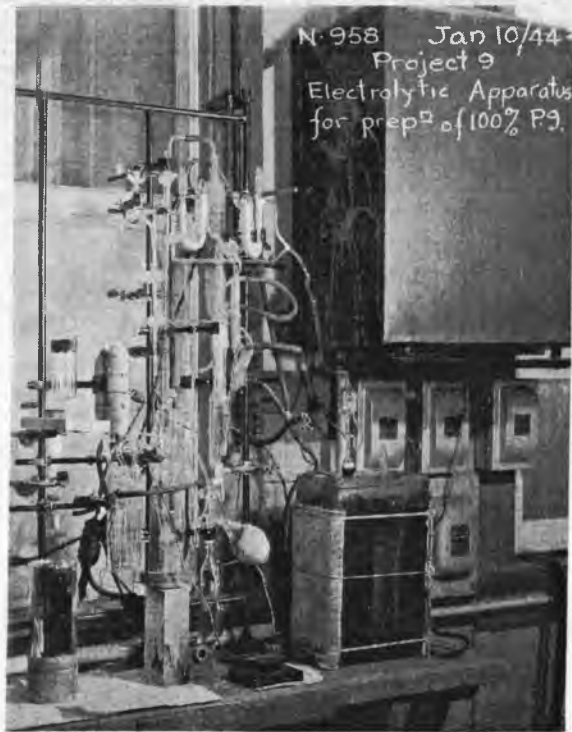

N-958 Jan 10/44
Project 9
Electrolytic Apparatus
for prepⁿ of 100% P₃.

~~SECRET~~

~~SECRET~~

81-25 Falling Drop Apparatus
(10 January 1944)

81-26 Pycnometers
(10 January 1944)

App. 81.16

~~SECRET~~

~~SECRET~~



N-954 Jan 10/44 Project
Falling Drop Apparatus

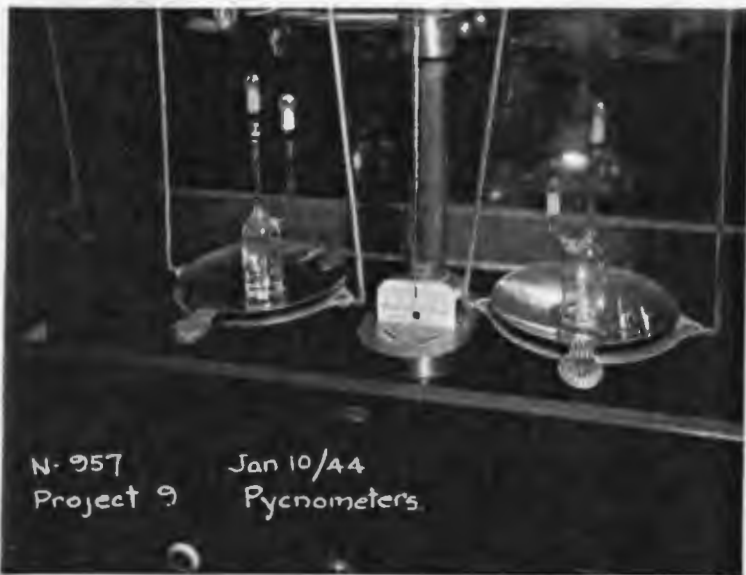

N-957 Jan 10/44
Project 9 Pycnometers

~~SECRET~~

~~SECRET~~

B1-27 Mass Spectrometers
(10 January 1944)

B1-28 Tower T-6 Oxygen Stripper from South
(13 October 1943)

App. B1.16

~~SECRET~~

~~SECRET~~



~~SECRET~~

~~SECRET~~

Bl-29 Boiler Plant
(15 April 1943)

App. Bl.17

~~SECRET~~

~~SECRET~~

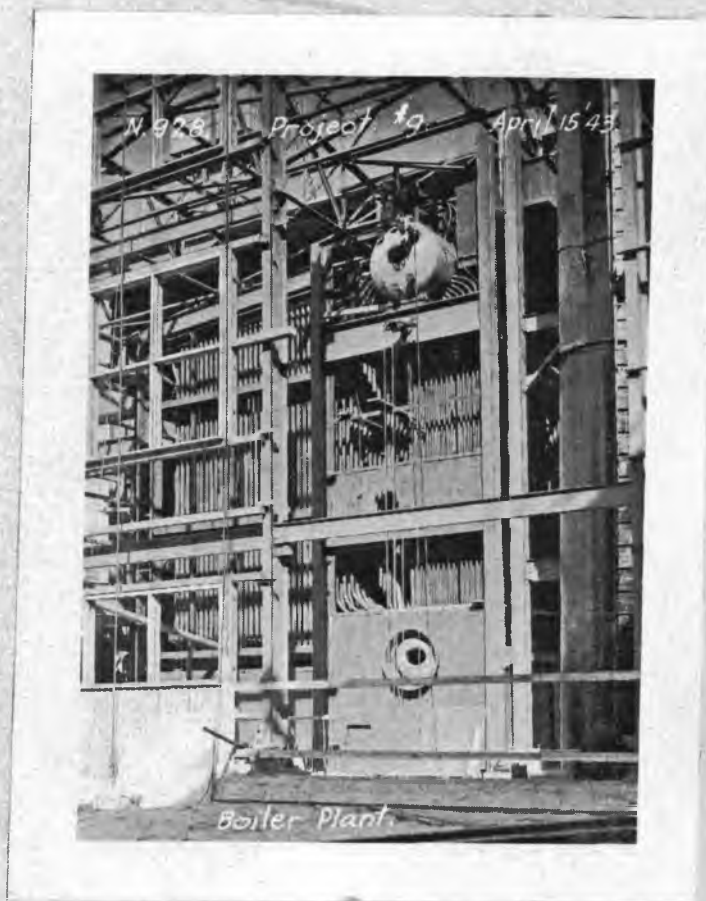

~~SECRET~~

~~SECRET~~

B2-1 Distillation Towers

App. B2.1

~~SECRET~~

~~SECRET~~



~~SECRET~~

~~SECRET~~

B2-2 Distillation Towers

App. B2.2

~~SECRET~~

~~SECRET~~

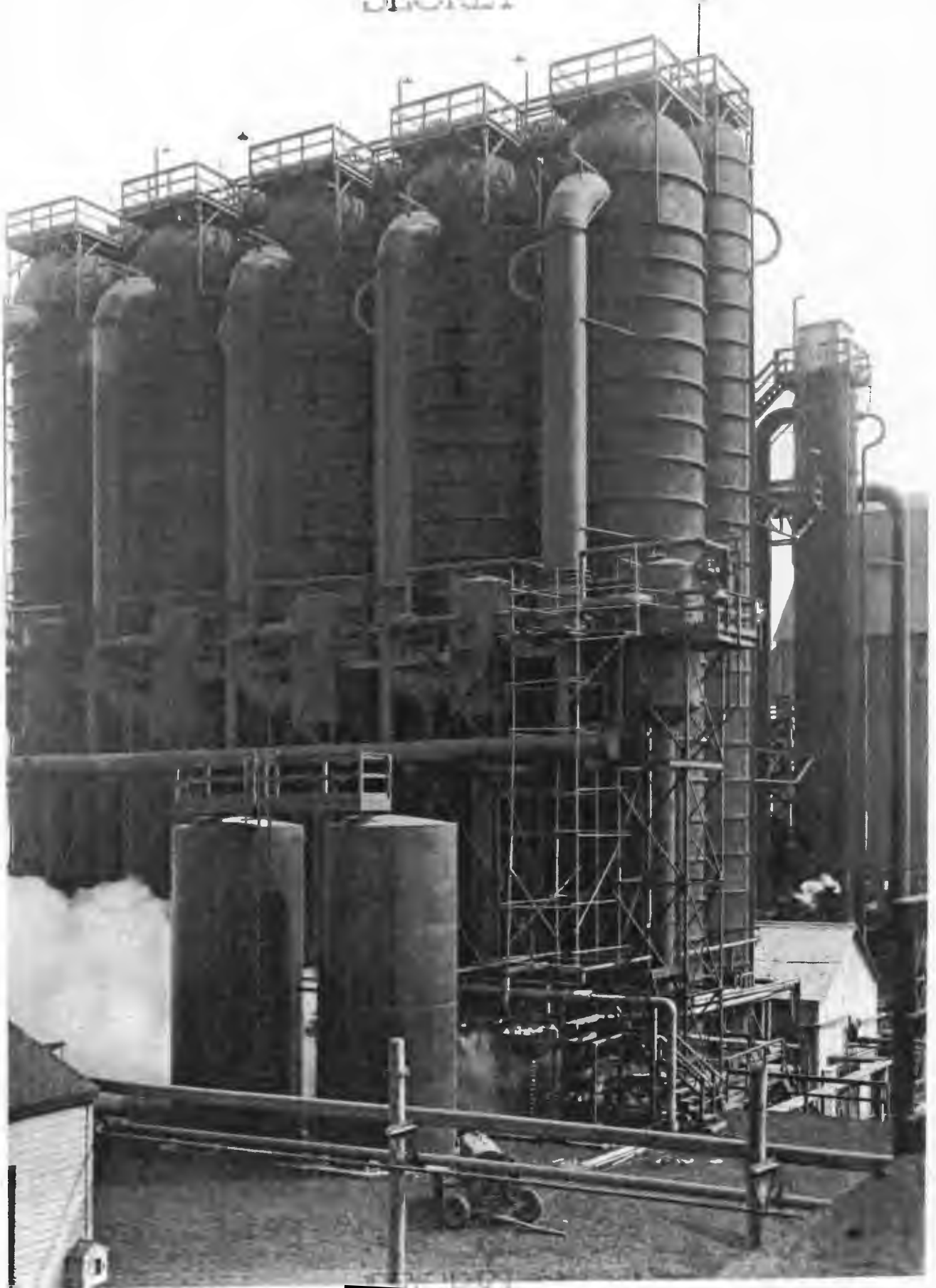

~~SECRET~~

~~SECRET~~

B2-3 Distillation Towers and Process Pump and Control Building

App. B2.3

~~SECRET~~



~~SECRET~~

SECRET

~~SECRET~~

B2-4 Right Wing, Change House, Office and Laboratory
Building

App. 32.4

~~SECRET~~

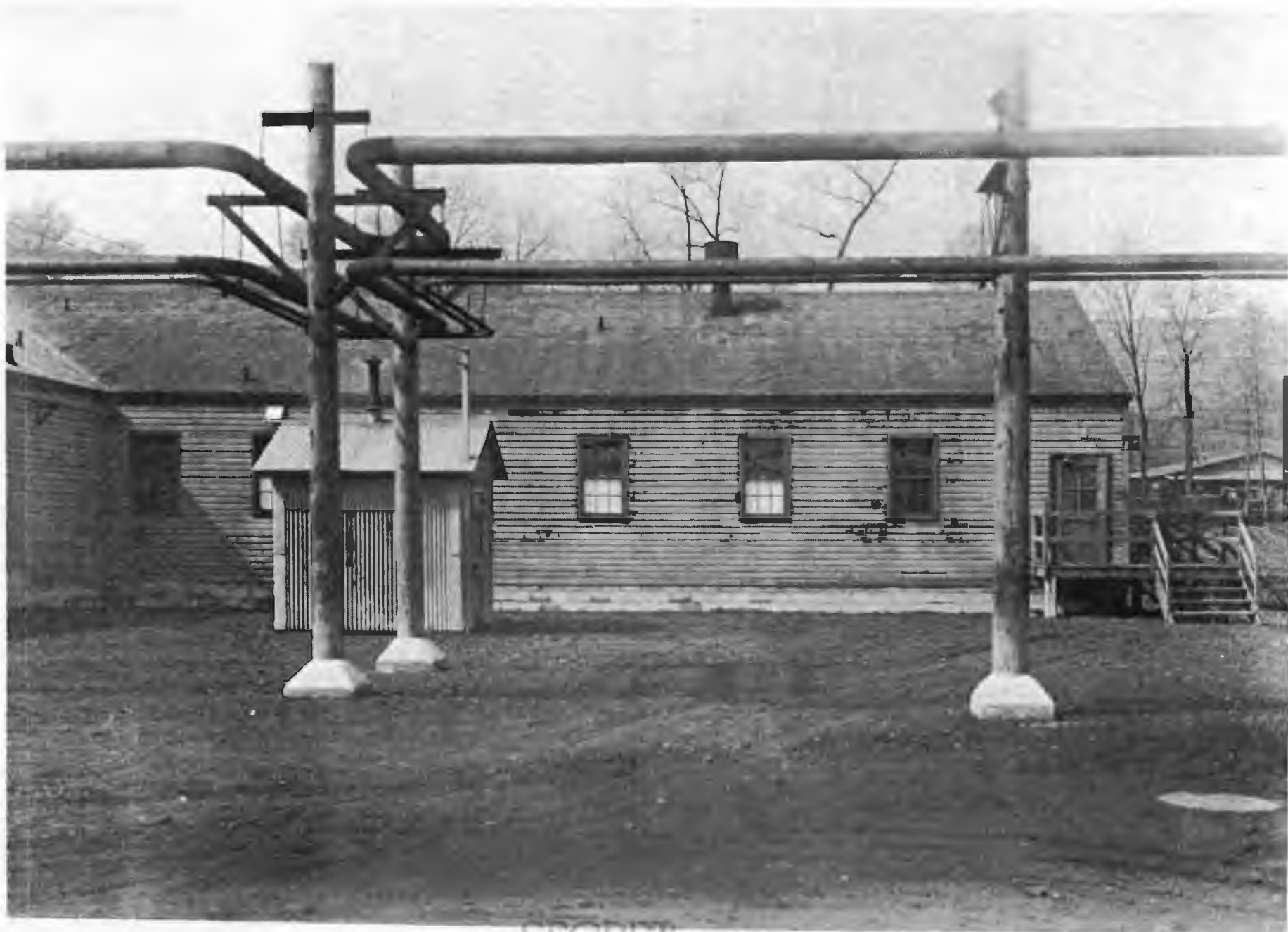

STODOL

CG/DET

~~SECRET~~

B2-5 Left Wing, Change House, Office and Laboratory
Building

App. B2.5

~~SECRET~~

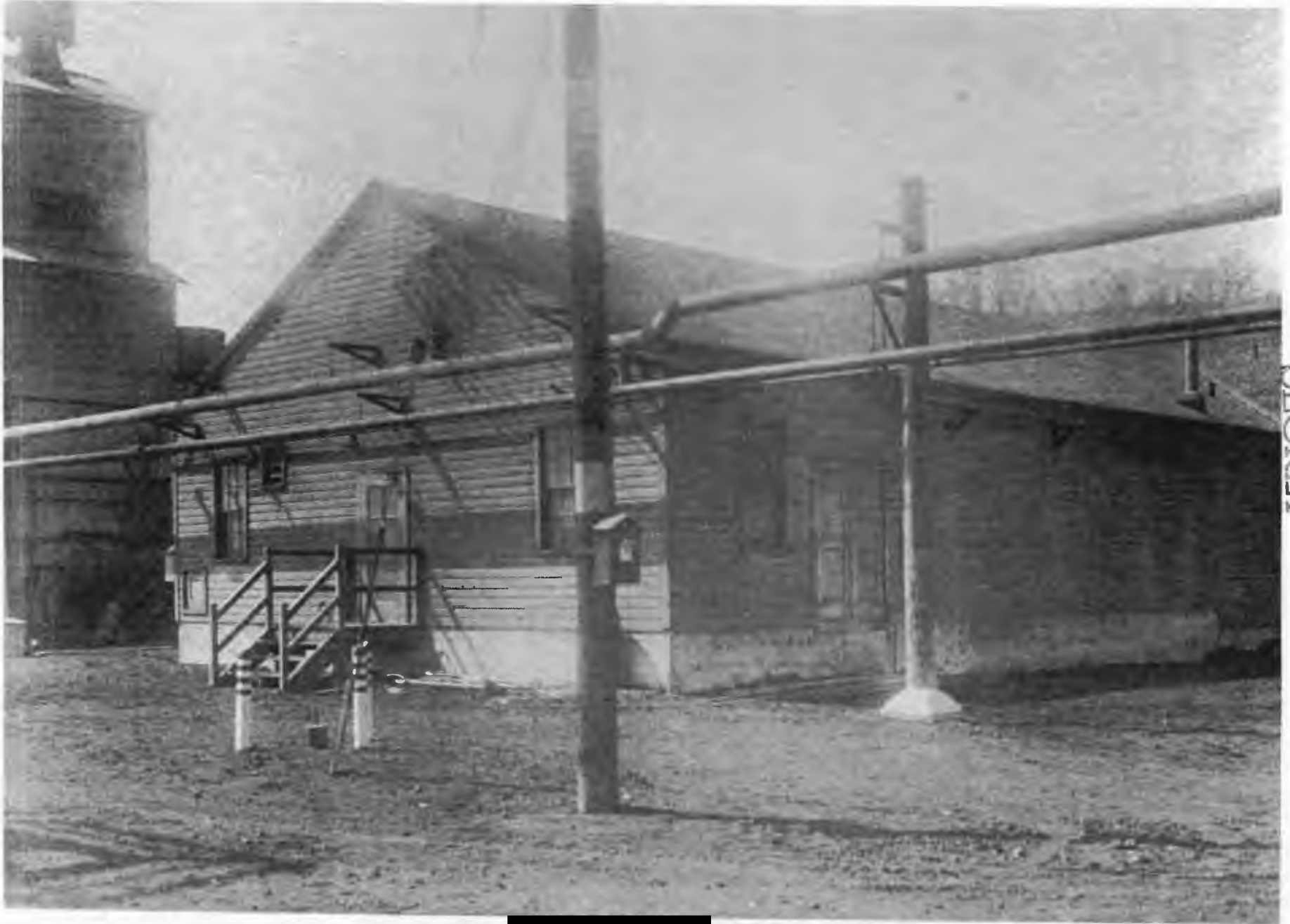

SECRET

24 504

~~SECRET~~

B2-6 Product Storage Building

App. B2-6

~~SECRET~~



SECRET

~~SECRET~~

B2-7 Cooling Tower

App. B2.7

~~SECRET~~

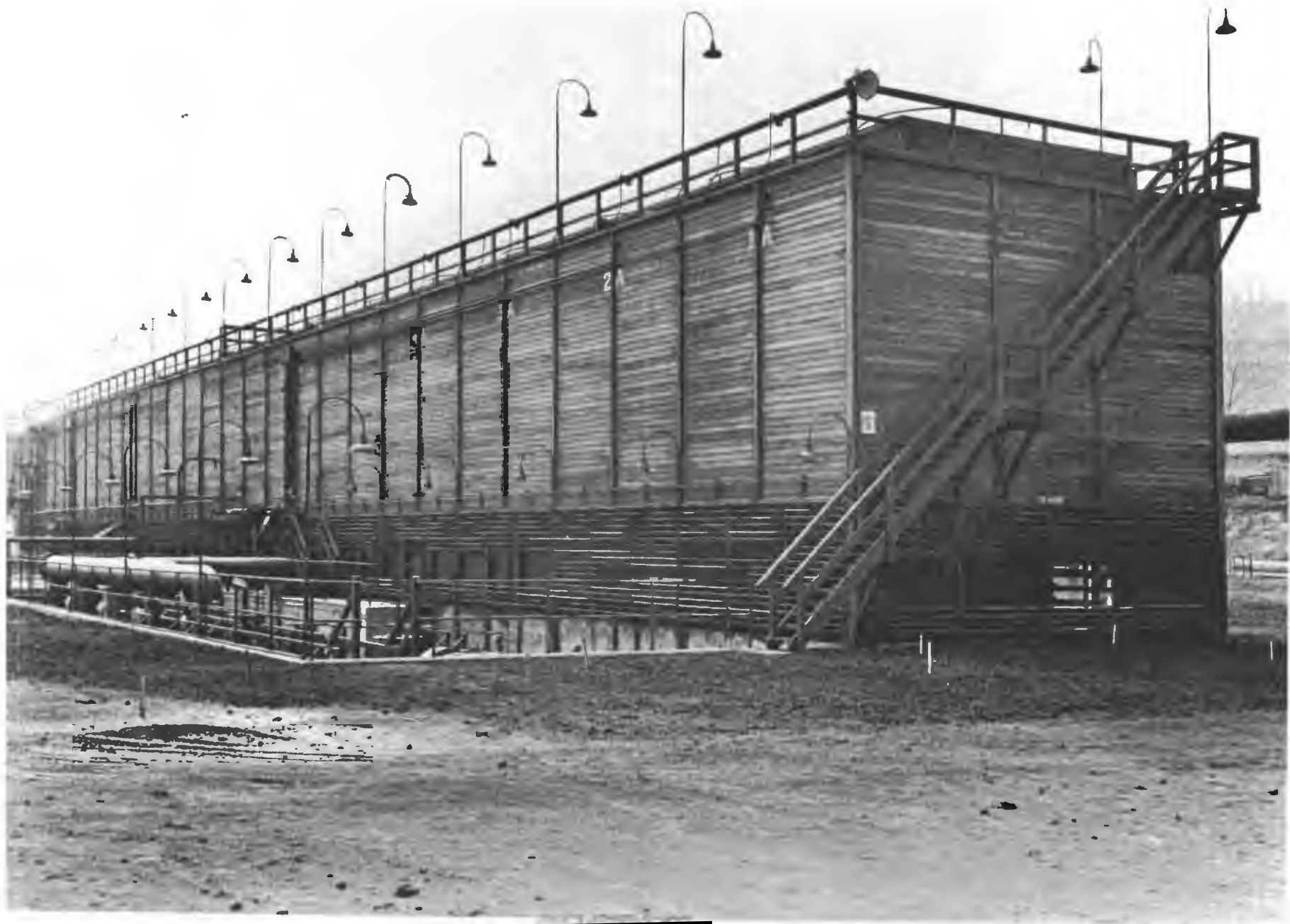

~~SECRET~~

B2-8 Finishing (Electrolytic) Building

App. 32.8

~~SECRET~~

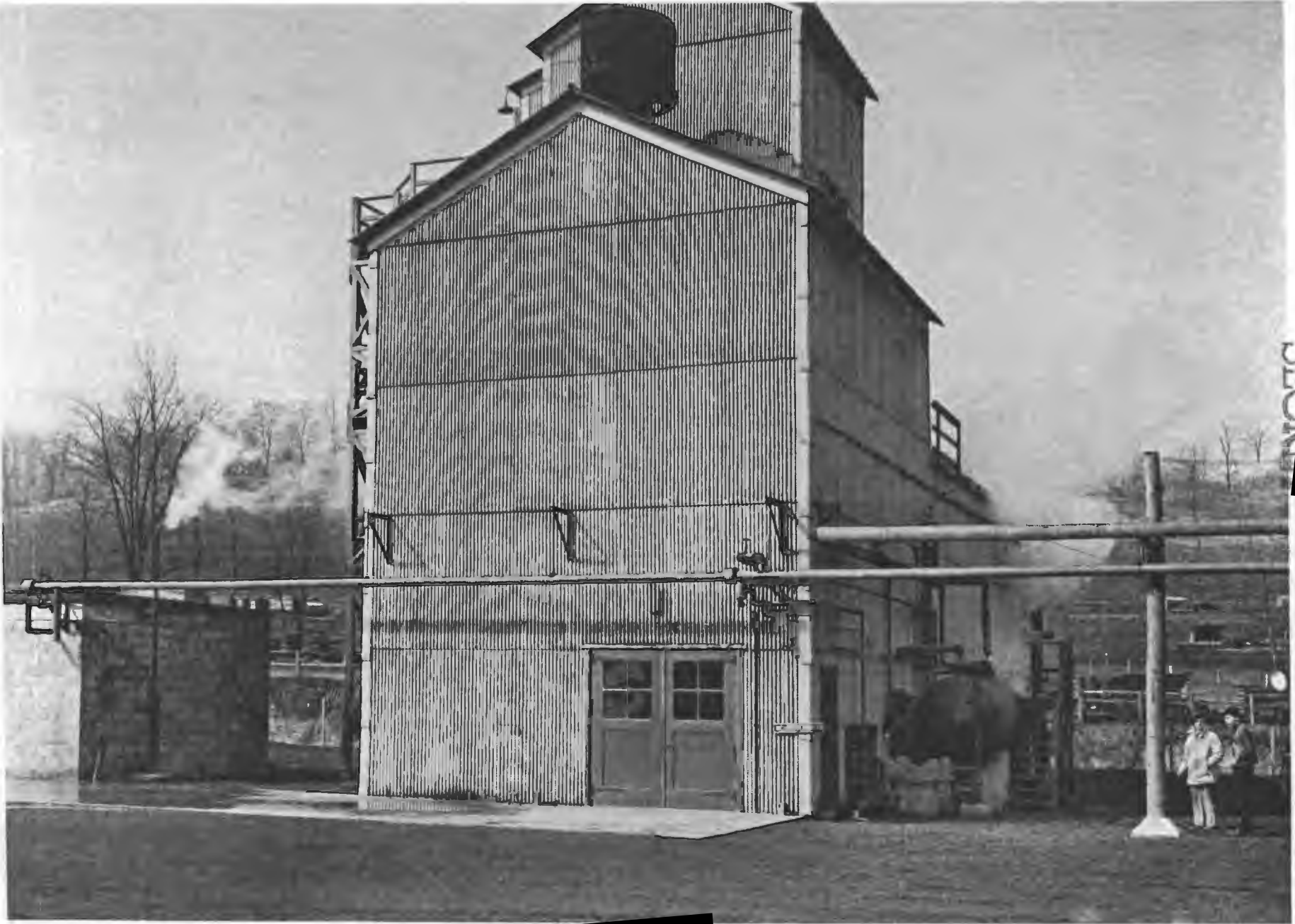

SECRET

[REDACTED]

~~SECRET~~

B2-9 Steam Supply Low Pressure Boiler House

App. B2.9

~~SECRET~~

~~SECRET~~

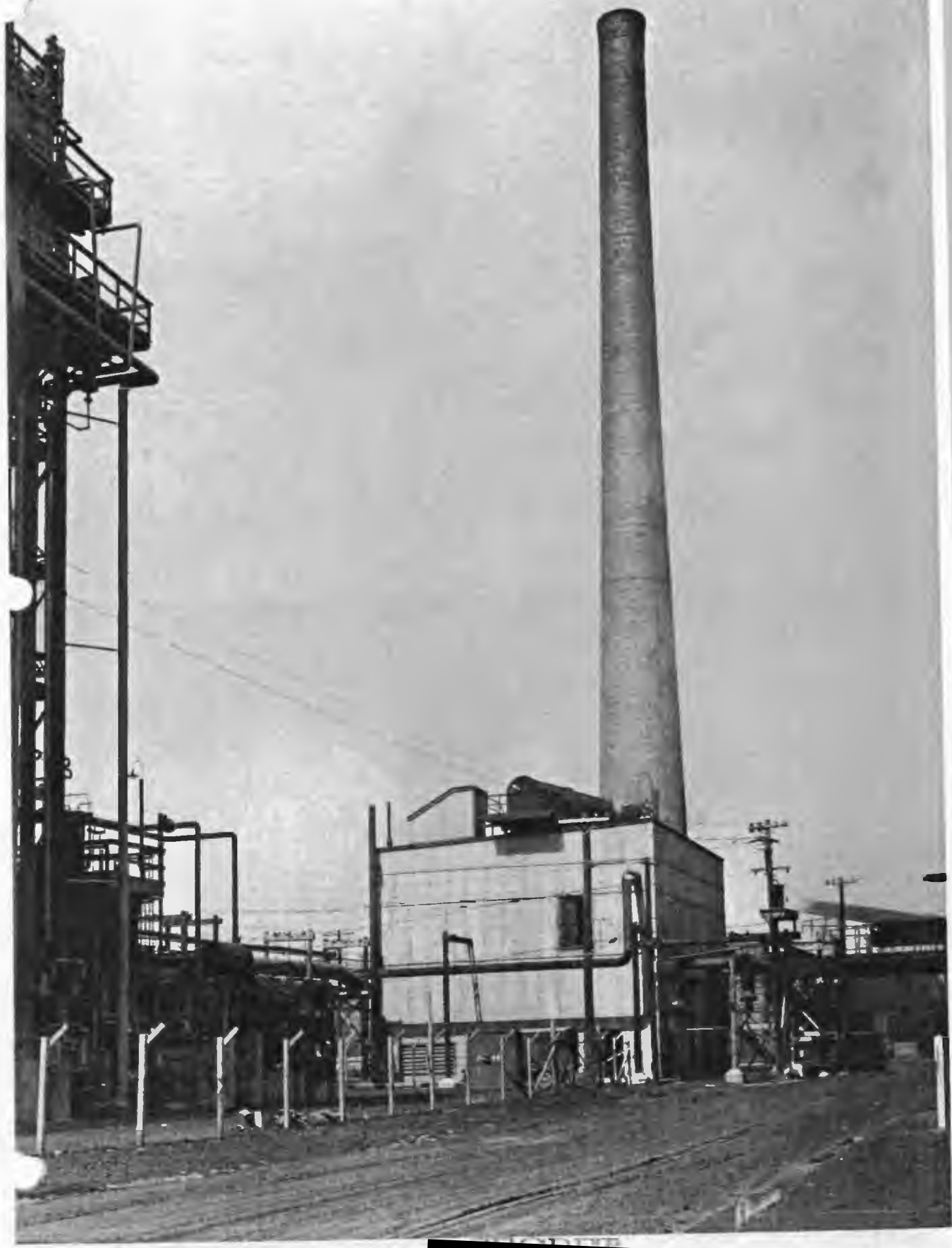

~~SECRET~~

~~SECRET~~

B3-1 Distillation Towers (October 1943)

App. B3.1

~~SECRET~~

52

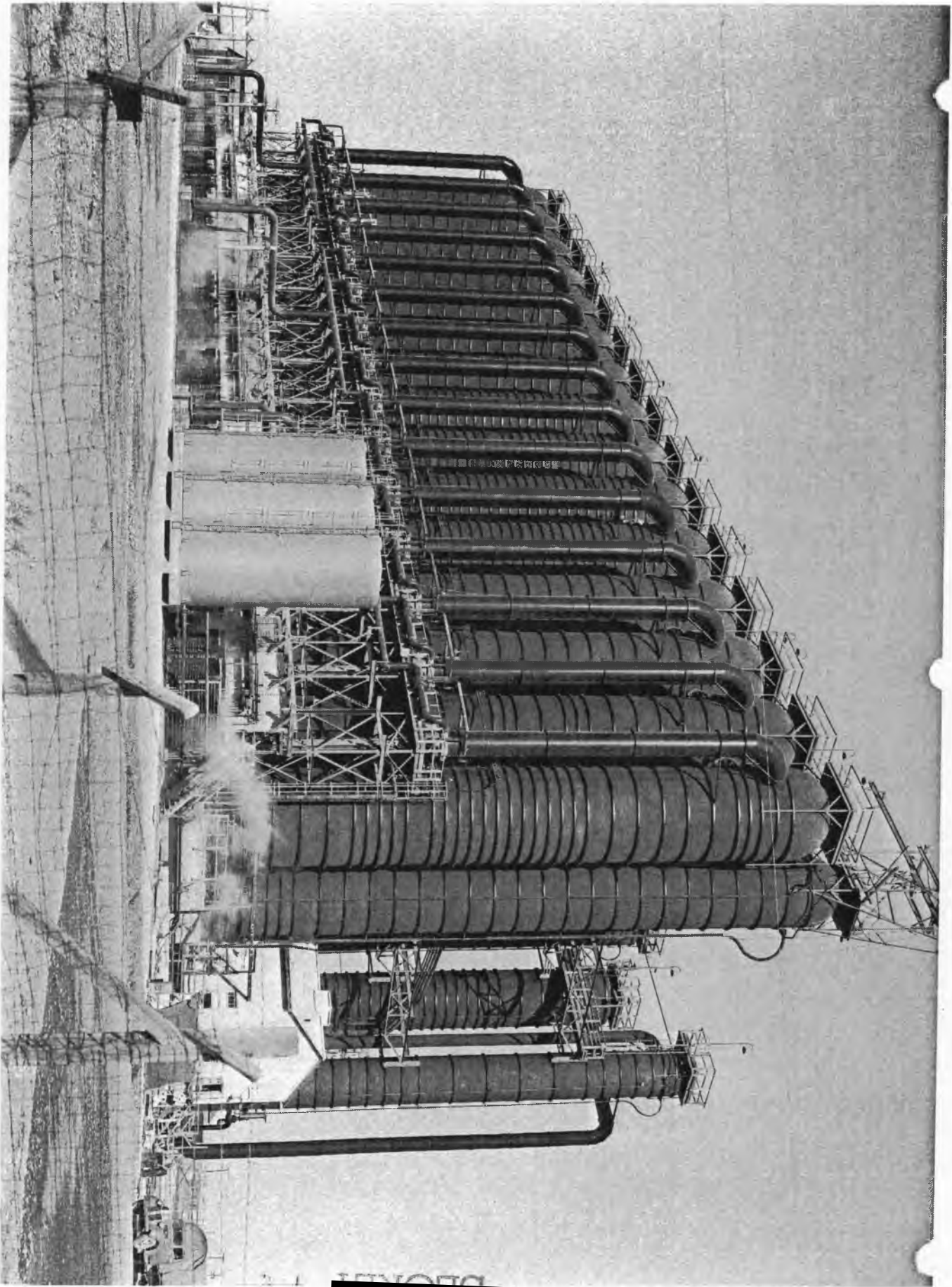

SECRET

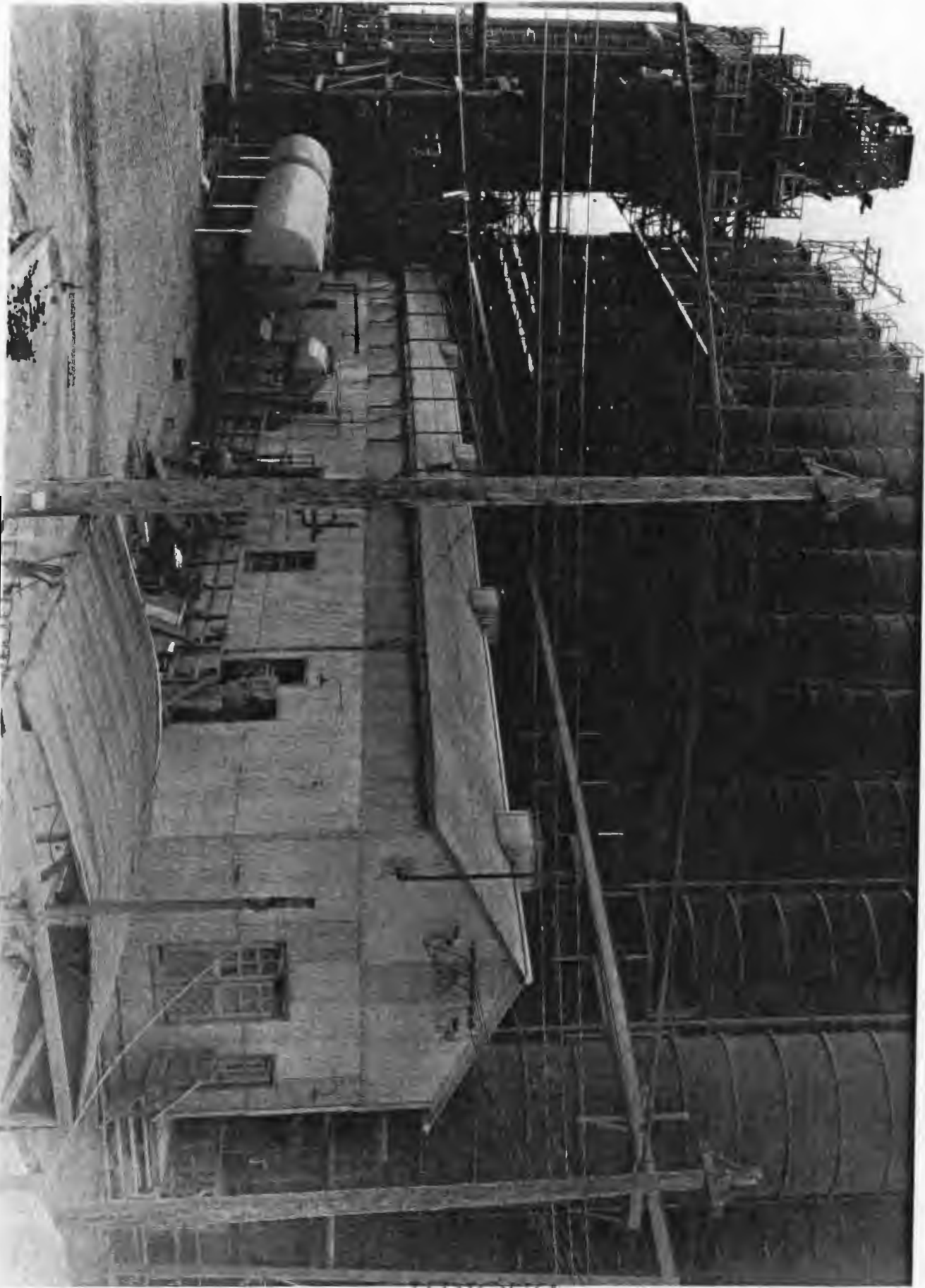

SECRET

SECRET

SECRET

~~SECRET~~

B5-2 Process Pump and Control Building, and Distillation
Towers (October 1945)

App. B5.2

~~SECRET~~

50

~~SECRET~~

B3-3 Change House, Office and Laboratory Building
(October 1943)

App. B3-3

~~SECRET~~



~~SECRET~~

B3-4 Ramney Water Collector Well
(October 1943)

App. 33.4

~~SECRET~~

~~SECRET~~

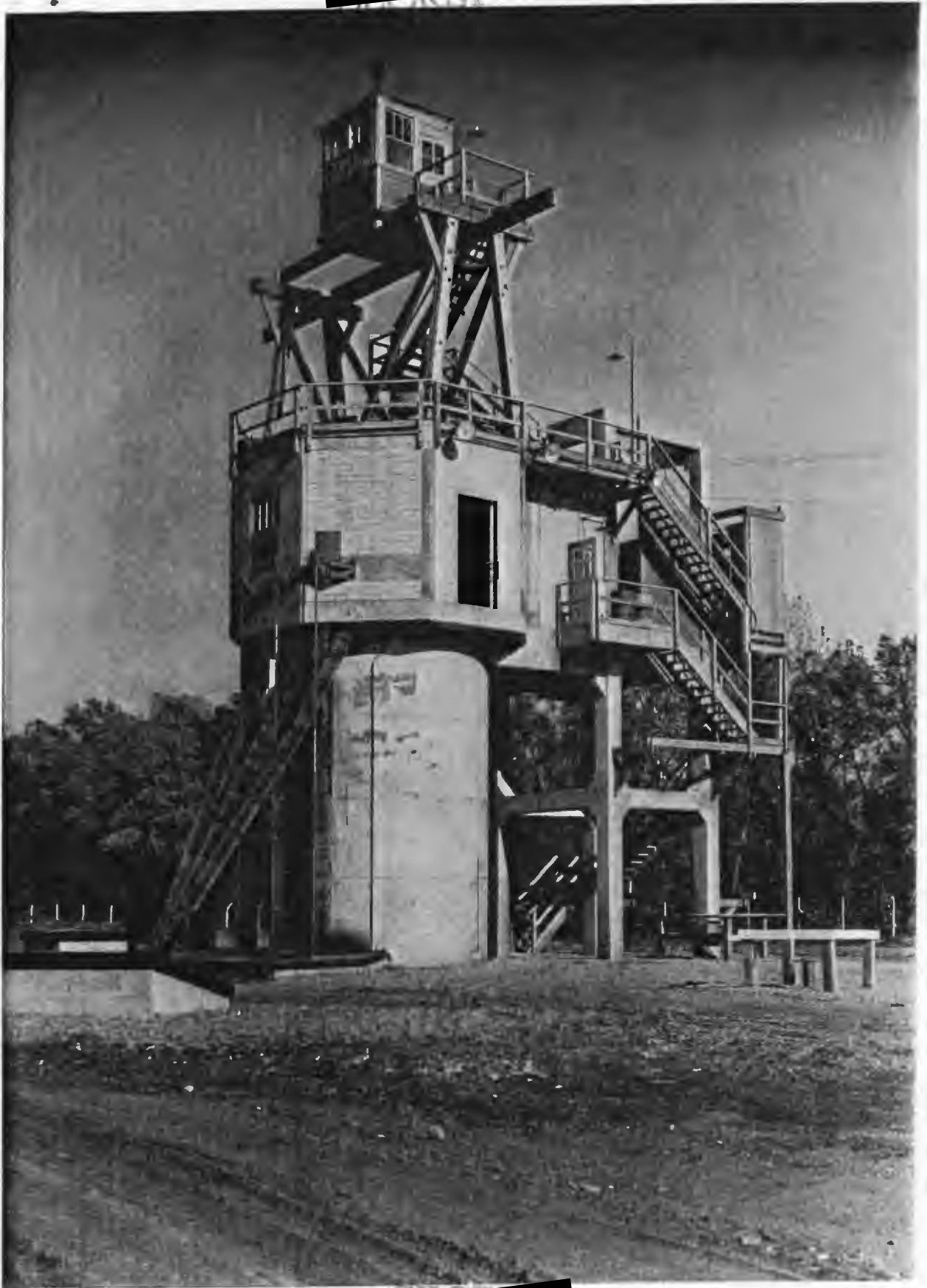

~~SECRET~~

~~SECRET~~

B3-5 Addition to Steam Power House
(in right foreground as indicated)
(October 1943)

App. B3.5

~~SECRET~~

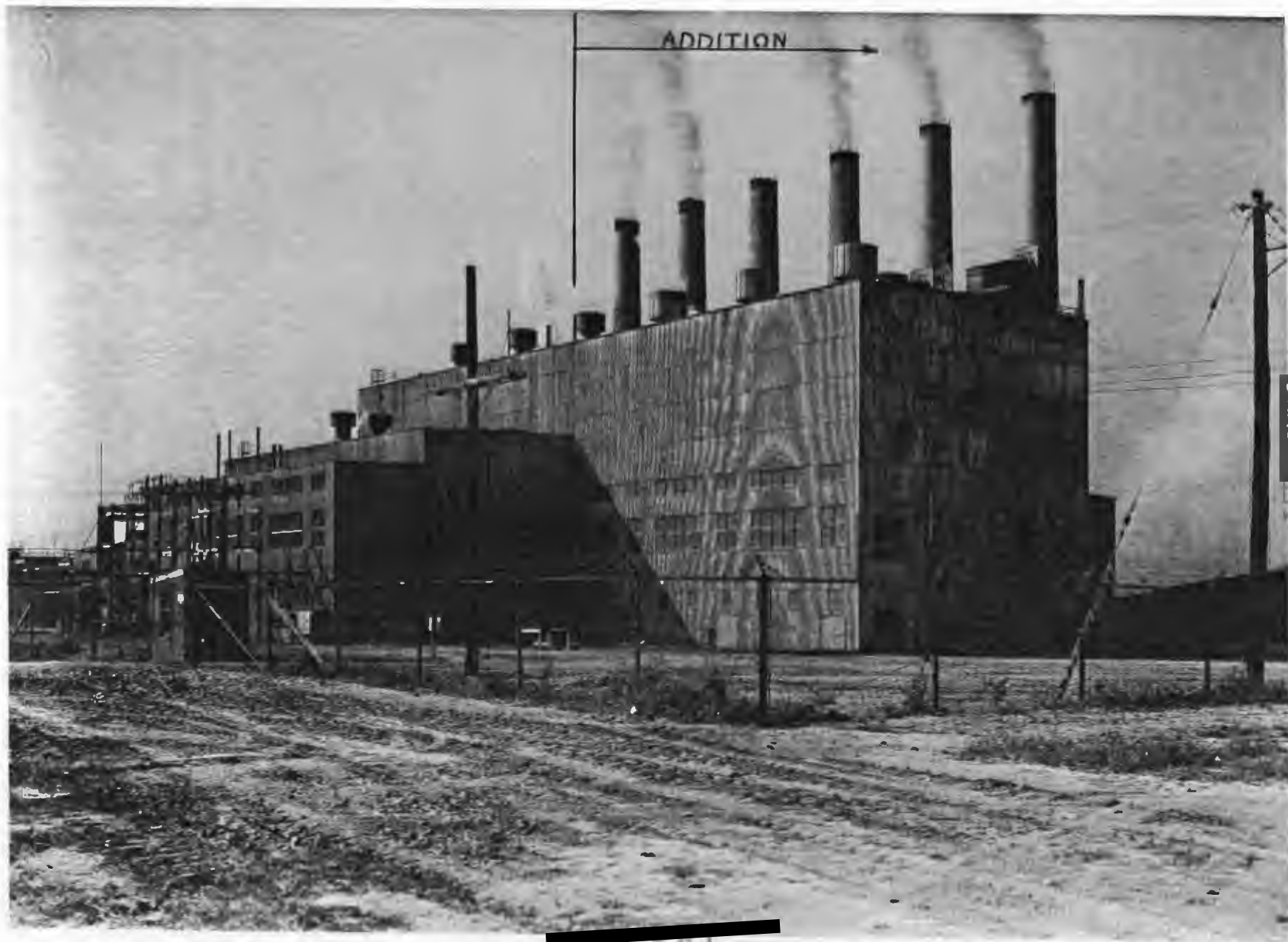

~~SECRET~~

B4-1 Distillation Towers (July 1943)

B4-2 Interior of Distillation Tower, during construction
(June 1943)

App. B4.1

~~SECRET~~

~~SECRET~~



~~SECRET~~

~~SECRET~~

**B4-3 Fabrication of Interior Bubble Cap Plate Sections
for Distillation Towers (May 1943)**

**B4-4 Fabrication of Interior Bubble Cap Plate Sections
for Distillation Towers (May 1943)**

App. B4.2

~~SECRET~~

~~SECRET~~

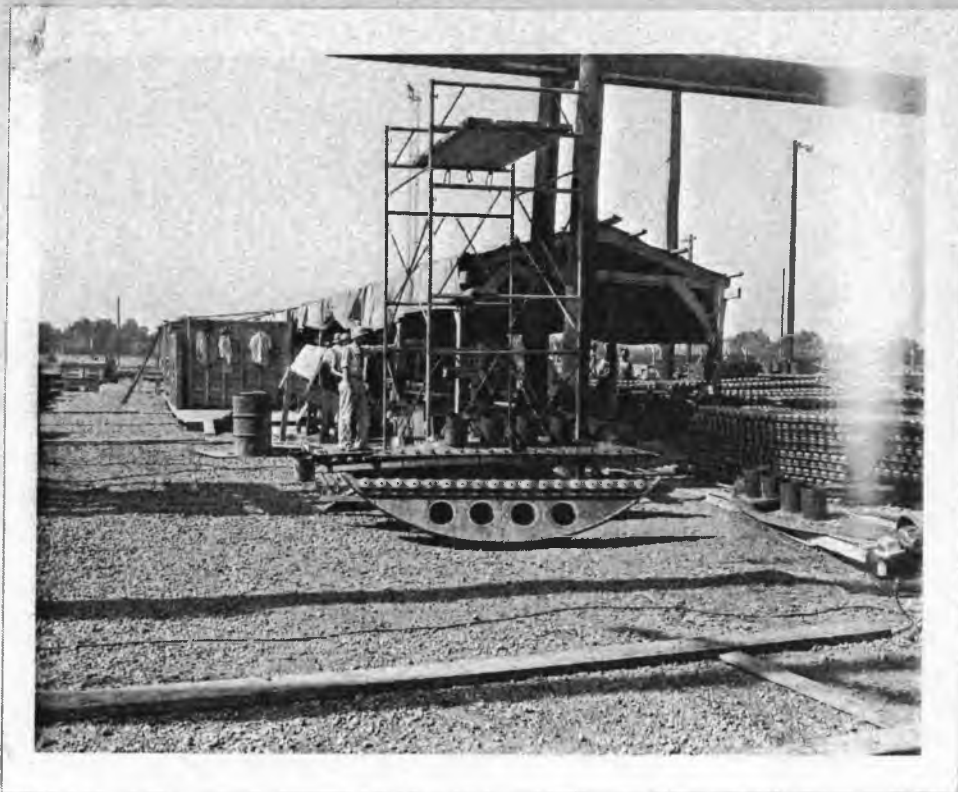
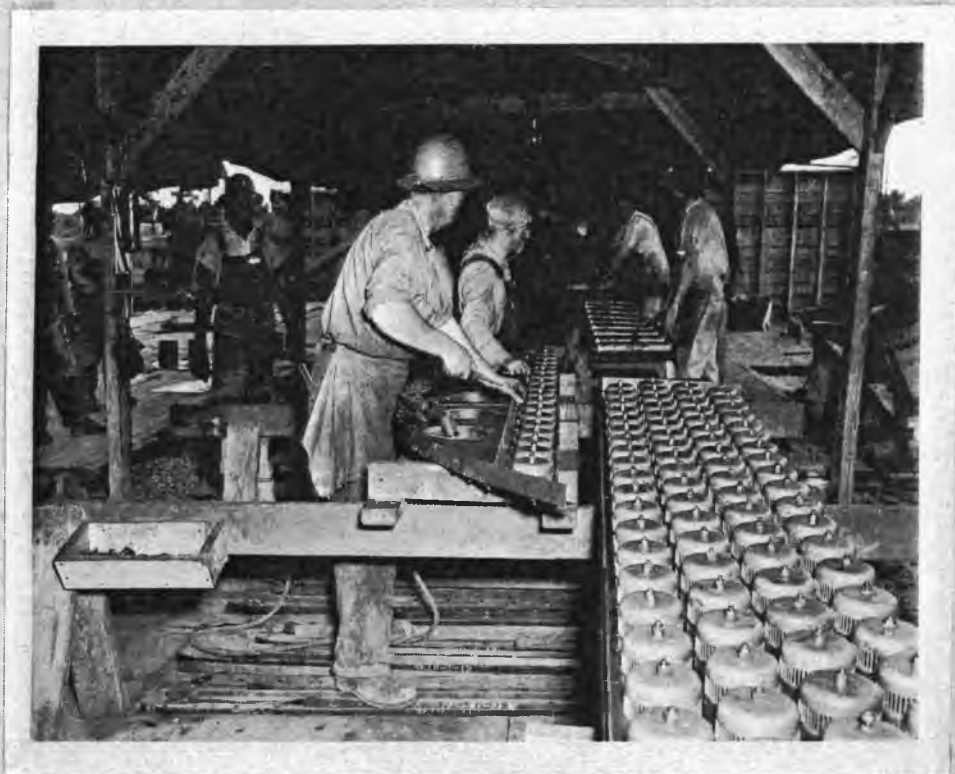

~~SECRET~~

~~SECRET~~

B4-5 Fabrication of Interior Bubble Cap Plate Sections
for Distillation Towers (May 1943)

B4-6 Top Section of Distillation Tower (May 1943)

App. B4.3

~~SECRET~~

~~SECRET~~

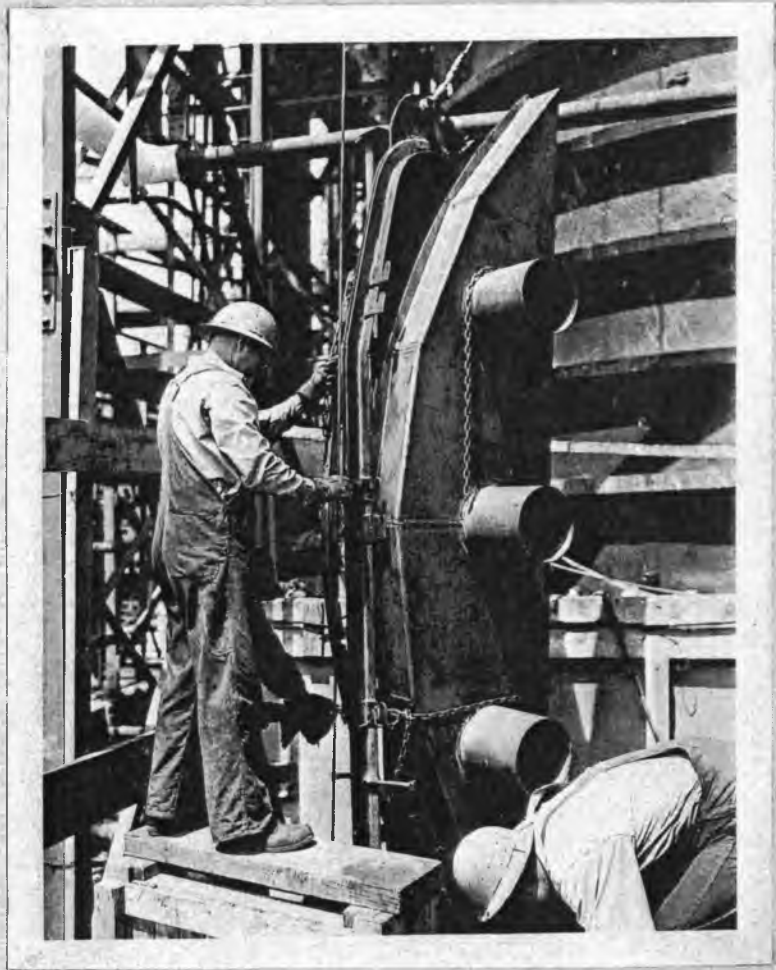

~~SECRET~~

~~SECRET~~

B4-7 Distillation Towers, from one side (November 1943)

B4-8 Distillation Towers, from near one end
(November 1943)

App. B4.4

~~SECRET~~

~~SECRET~~

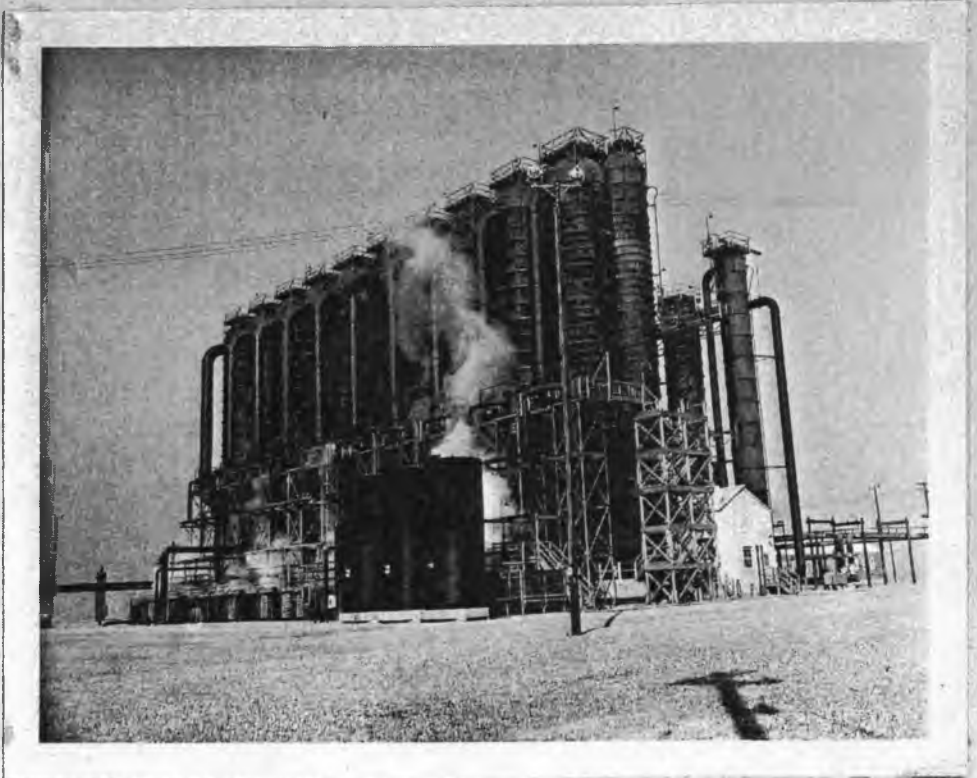
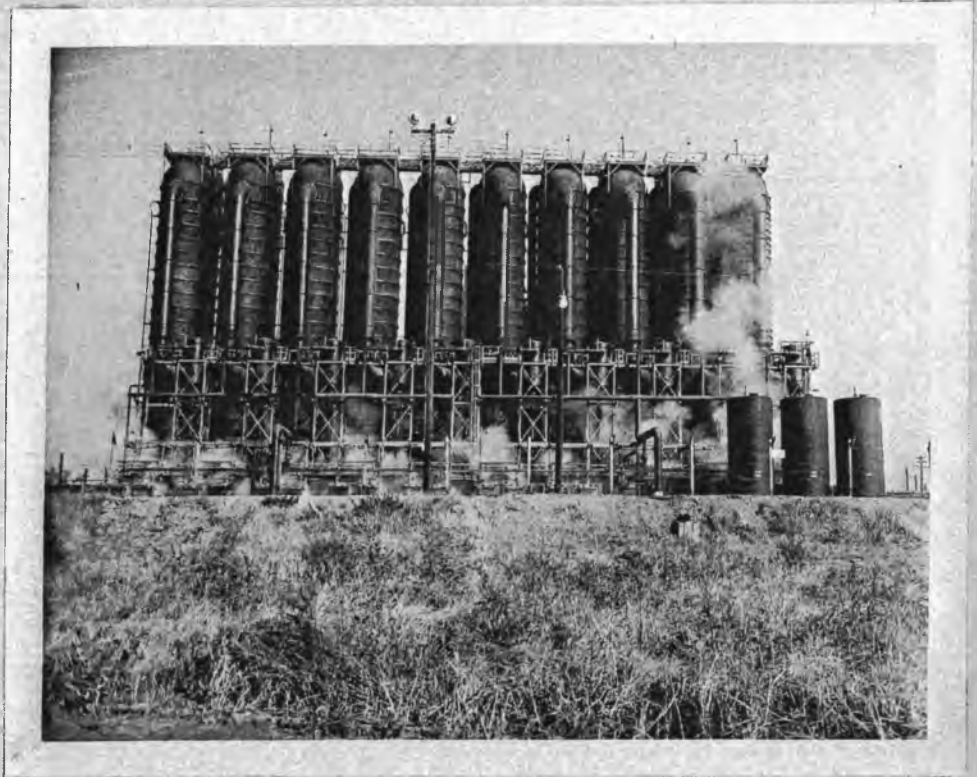

~~SECRET~~

~~SECRET~~

B4-9 Process Pump and Control Building (July 1943)

B4-10 Process Pump and Control Building (November 1943)

App. B4.5

~~SECRET~~

~~SECRET~~

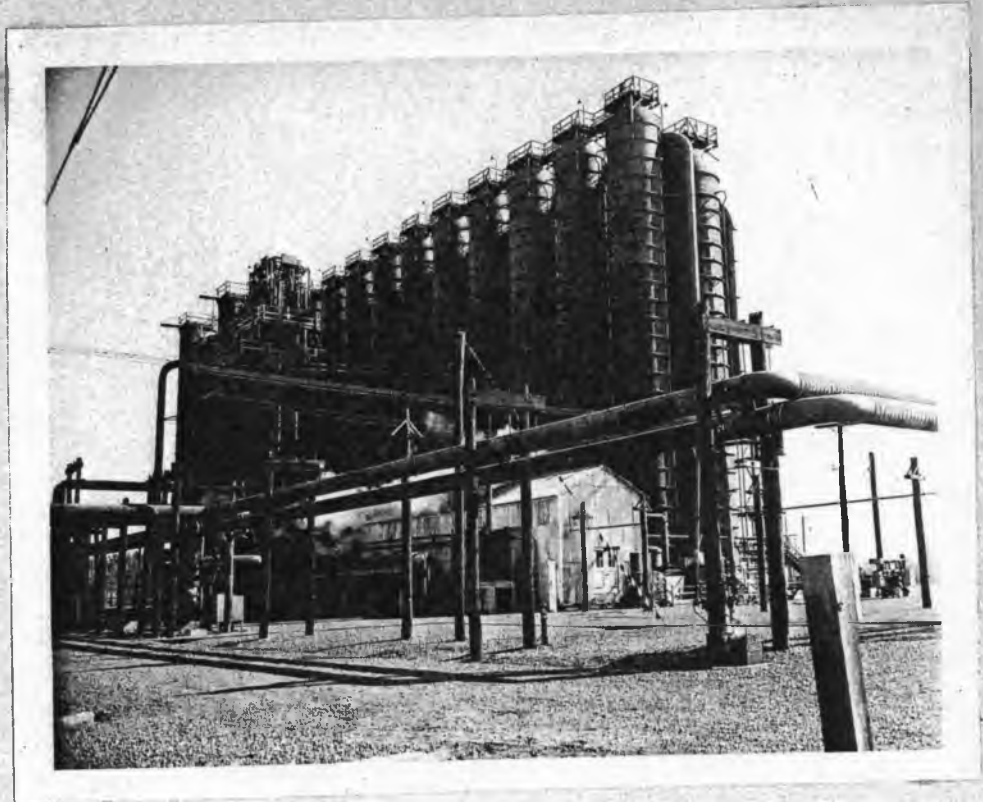
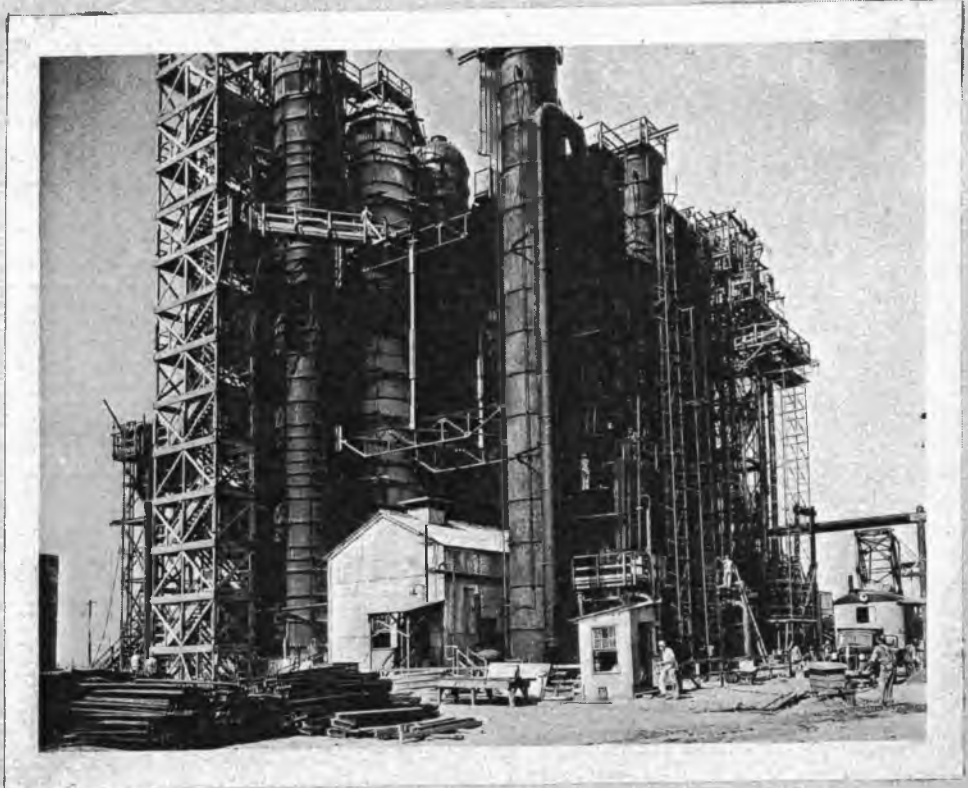

~~SECRET~~

~~SECRET~~

**B4-11 Change House, Office and Laboratory Building
(November 1943)**

B4-12 Product Storage Building (November 1943)

App. B4.6

~~SECRET~~

~~SECRET~~



~~SECRET~~

~~SECRET~~

B4-13 Area Gate and Guard House (November 1943)

B4-14 Warehouse or Shop (November 1943)

App. B4.7

~~SECRET~~

~~SECRET~~



~~SECRET~~

~~SECRET~~

APPENDIX C

LISTS OF SPECIAL DOCUMENTS

- C1. Technical Reports. MED Research Control Section File.
- C2. Contracts. MED Classified Contract Files.

App. C

~~SECRET~~

~~SECRET~~

APPENDIX C1

TECHNICAL REPORTS

(Filed in MED Research Control Section File)

<u>Report Number</u>	<u>Subject</u>	<u>By</u>	<u>Date</u>
A-102	Hydrogen-Exchange Reaction on Metal Catalysts.	H. S. Taylor G. G. Joris	Undated
A-104	The Calculation of the Performance of Exchange Columns for the Separation of Hydrogen Isotopes	G. E. Kimball	24 Jan 1942
A-115	Catalysts for the Production of Heavy Water by Means of the Hydrogen Water Exchange Reaction.	A. V. Grosse	15 Jan 1942
A-144	Theoretical Values of Equilibrium Constants for Deuterium Exchange Reactions Involving Hydrogen & Water.	G. E. Kimball W. H. Stockmayer	7 Apr 1942
A-160	Third Progress Report on the Hydrogen-Water Vapor Exchange Reaction on Metal Catalysts.	H. S. Taylor	17 Apr 1942
A-258	Sixth Progress Report on the Hydrogen-Water Vapor Exchange Reaction on Metal Catalysts.	G. G. Joris H. S. Taylor	27 Aug 1942
A-299	Second Report on Catalysts for the Production of Heavy Water by Means of the Hydrogen-Water Exchange Reaction.	J. E. Ahlberg C. F. Hiskey J. R. Huffman E. H. Taylor A. V. Grosse	Undated
A-315	Reliability of Catalyst Testing Procedures at Columbia.	R. H. Crist	23 Sep 1942
A-327	Calculation of the Performance of Exchange Tower in the Production of Heavy Water.	H. C. Carlson J. O. Maloney	7 Oct 1942
A-359	Continuous Deuterium Analysis.	Malcolm Dole R. L. Burwell, Jr. R. J. Voskuyl W. E. Roake	4 Nov 1942

C1.1

~~SECRET~~

~~SECRET~~

Report Number	Subject	By	Date
A-361	Columbia Mass Spectrometers.	H. M. Kelley D. S. McClure C. E. Herrick, Jr.	27 Oct 1942
A-364	Theoretical Values of Equilibrium Constants for Deuterium Exchange Reactions Involving Hydrogen Sulfide.	W. H. Stockmayer H. Jacobson	29 Oct 1942
A-393	The Concentration of Deuterium by the S-Process. Fundamental Principles and Basis of Calculations.	J. S. Spevak	3 Dec 1942
A-394	Final Report Under Contract No. OEMsr-776 for the Production of HDO Water by the Direct Method.	M. G. Amick	4 Dec 1942
A-398	Memorandum on Life Tests Conducted on Baker Pt-Charcoal Catalysts.	H. S. Taylor	5 Dec 1942
A-399	Cyclohexane-Benzene-Hydrogen as a Possible System for the Concentration of Deuterium.	H. S. Taylor G. G. Joris	5 Dec 1942
A-400	Progress Report on the Experimental Determination of the Equilibrium Constant for the Reaction between Deuterium Oxide and Hydrogen Sulfide.	H. S. Taylor	4 Dec 1942
A-401	Memorandum on Testing Program for Platinum-Charcoal Catalysts Prepared by Baker & Co. for use at No. 9 Project, Trail, B. C.	H. S. Taylor	5 Dec 1942
A-501	Contains following reports relative to Project No. 9.		14 Jan 1943
	<u>a.</u> Progress Report of Thermal Studies at the Ohio State University. (Columbia Serial No. 100XR-18)	H. L. Johnston	9 Jan 1943
	<u>b.</u> Monthly Report on the D Process. (Columbia Serial No. SR-21)	J. R. Huffman	7 Jan 1943
	<u>c.</u> Monthly Report on the W Process. (Columbia Serial No. SR-25).	J. R. Huffman	7 Jan 1943

C1.2

~~SECRET~~

~~SECRET~~

Report Number	Subject	By	Date
	<u>d.</u> Catalysts for Water-Hydrogen and Ammonia-Hydrogen Exchange. (Columbia Serial No. 2A-R-4).	H. R. Arnold	9 Jan 1943
	<u>e.</u> Progress Report No. 3. Properties of Test Batches of Product 80. (Columbia Serial No. 100XR-26).	G. M. Webb	8 Jan 1943
	<u>f.</u> Progress Report of the Chemical Research Group 9 Dec 1942 to 9 Jan 1943. The Separation of Deuterium. (Columbia Serial No. 2B R-3).	R. H. Crist	7 Jan 1943
	<u>g.</u> Eighth Progress Report on the Hydrogen-Water Vapor Exchange on Metal Catalysts. (Columbia Serial No. 100XR-25).	G. G. Joris	7 Jan 1943
	<u>h.</u> Progress Report on Dual Temperature Systems. (Columbia Serial No. 3R-23)	J. H. Chapin	5 Jan 1943
	<u>i.</u> Progress Report. Catalyst-Poisoning Experiments. Five Stage Catalyst Column and Electrolytic Cell Pilot Plant. (Columbia Serial No. 3A-R-5).	C. F. Hiskey	6 Jan 1943
	<u>j.</u> Progress Report of Disposal and Development of Spectrometers. (Columbia Serial No. 100XR-21).	A. O. C. Nier	7 Jan 1943
A-510	The N Process.	G. F. Quinn	4 Jan 1943
A-513	Equilibrium Constant, HDO + H ₂ S.	H. S. Taylor	16 Jan 1943
A-514	Progress Report for December, 1942 on Preparation of 4th Pilot Plant Batch (Universal Oil Products Co.) and Transmittal Letter.	G. M. Webb	19 Jan 1943
A-526	E. I. du Pont de Nemours Co. Monthly Report, Jackson Laboratory.	W. S. Calcott	9 Mar 1943
A-527	Final Report on Work Done Under Extension of Contract No. OEMsr-482. Deuterium Content of Some Water Samples.	Malcolm Dole L. P. Saxer	1 Feb 1943
A-528	Progress Report by Engineering Laboratory.	C. F. Hiskey	12 Feb 1943

Cl.3

~~SECRET~~

~~SECRET~~

Report Number	Subject	By	Date
A-532	Ninth Progress Report on Hydrogen-Water Exchange Reaction on Metal Catalysts.	H. S. Taylor	12 Feb 1943
A-534	Progress Report No. 4 on Manufacture of Product No. 80 for Project No. 9.	G. M. Webb	13 Feb 1943
A-537	Monthly Progress Report, Chemistry Division, Deuterium Separation-Dual Temperature Systems.	R. H. Crist	13 Feb 1943
A-539	Catalysts for Water-Hydrogen and Ammonia Hydrogen Exchange. Progress Report from 9 January to 15 February 1943.	H. R. Arnold	15 Feb 1943
A-541	The S Plant.	J. H. Chapin G. F. Quinn	17 Feb 1943
A-544	The W Process, Monthly Report. Construction of Plants by du Pont Co. for Production of Heavy Water by the Distillation of Water.	J. R. Huffman	11 Feb 1943
A-545	The Operation of a Glass Five Stage Catalytic Heavy Water-Hydrogen Exchange Tower.	M. L. Eidinoff E. V. Sayre C. F. Hiskey	15 Feb 1943
A-548	Effect of Risons on Products No. 43 and No. 80. Report No. 1.	C. F. Hiskey M. L. Eidinoff	20 Apr 1943
A-549	The Effect of Temperature on the Murphree Plate Efficiency for the D Exchange between Water and Hydrogen Sulfide.	J. S. Spevack J. R. Huffman	24 Feb 1943
A-553	Report No. 2 on the Operation of a Glass Five Stage Catalytic Heavy Water Exchange Tower; The Effect of Super-Heat.	M. L. Eidinoff E. V. Sayre C. F. Hiskey	8 Mar 1943
A-556	The W Process; Literature Survey on the Fractionation Factor.	J. R. Huffman	9 Mar 1943
A-559	The Use of A Separating Agent in the Extraction or Distillation of HDO from H ₂ O Apparent Increase.	A. F. Colburn	16 Feb 1943

Cl.4

~~SECRET~~

~~SECRET~~

Report Number	Subject	By	Date
A-560	S Process, Revision of Five Ton Per Month Plant Design.	J. H. Chapin	9 Mar 1943
A-562	Progress Report by Engineering Laboratory.	C. F. Hiskey	12 Mar 1943
A-563	Progress Report by Engineering Laboratory.	C. F. Hiskey	12 Mar 1943
A-564	Hydrogen Exchange. Progress Report 15 February to 15 March, 1943.	H. R. Arnold	15 Mar 1943
A-566	The Separation of Deuterium. Progress Report on the Chemical Research Group 2B - 10 February to 11 March 1943.	F. B. Brown	12 Mar 1943
A-576	Analysis for Deuterium in Water by Equilibration with Hydrogen.	J. S. Smith C. A. Hutchison C. M. Judson	23 Apr 1943
A-579	S Process; Comparison of Five Ton Per Month Plant Designs.	J. H. Chapin G. E. Quinn	6 Apr 1943
A-582	S Process Data - Temperature Coefficient of Exchange Constant for the Hydrogen Sulfide - Water System.	D. S. McClure C. E. Herrick, Jr.	8 Apr 1943
A-583	Report No. 5 on the Operation of a Glass Five Stage Catalytic Heavy Water - Hydrogen Exchange Tower: A study of Operation in the 50° Temperature Range.	M. L. Eidinoff E. V. Sayre C. F. Hiskey	5 Apr 1943
A-588	M. I. T. Monthly Progress Report for April on WX Process.	Geo. Soatchard	13 Apr 1943
A-589	Tenth Progress Report on the Hydrogen-Water Vapor Exchange on Metal Catalysts.	H. S. Taylor	14 Apr 1943
A-590	Project No. 9 - Catalysts for Water-Hydrogen Exchange. Monthly Progress Report 15 March to 15 April 1943.	H. R. Arnold	- - -

C1.5

~~SECRET~~

~~SECRET~~

Report Number	Subject	By	Date
A-591	The Separation of Deuterium, 12 March to 14 April 1943.	F. B. Brown	- - -
A-595	Vapor Liquid Equilibrium Data for the System H ₂ O-HDO in the Range of Two Mol Percent HDO.	P. W. Schutz	12 Apr 1943
A-597	S-Process, Temperature and Pressure vs. Efficiency.	J. S. Spevaok E. J. Grabowski	17 Apr 1943
A-598	M.I.T. Monthly Report for May on WX Process.	Geo. Scatchard	12 May 1943
A-608	Report #1. Operation of Experimental Cells No. 1 and No. 2 for Secondary Concentration. Report #2. Electrical Tests During a Period of Operation of the Secondary Pilot Plant. (Trail)	J. M. Douglas J. M. Douglas A. P. Blake	11 Nov 1942 2 Dec 1942
A-707	Columbia Monthly Report for Product 9.	R. H. Crist	15 May 1943
A-714	Effect of Poisons on Products No. 43 and No. 80.	C. F. Hiskey R. I. Klebanow S. Steingiser	7 June 1943
A-715	Report No. 4 (Final) on Operation of a Glass Five Stage Catalytic Heavy Water-Hydrogen Exchange Tower; Performance Using Product No. 80.	C. F. Hiskey A. Teller	1 June 1943
A-716	A Review of Research and Development of the Dual Temperature Process for Concentrating Deuterium.	M. L. Eidinoff C. F. Hiskey	29 June 1943
A-718	Glass Unit S-Process. The Operation of a Dual-Temperature Single Stage Tower for Deuterium Concentration.	M. L. Eidinoff C. F. Hiskey	28 May 1943
A-722	Analysis of Low Deuterium Water by the Mass Spectrometer.	B. Weinstock	21 May 1943
A-723	Analysis of Heavy Water on the Interferometer.	I. Kirshenbaum	Aug 1942

Cl.6

~~SECRET~~

~~SECRET~~

Report Number	Subject	By	Date
A-724	Comparison of the Columbia Spectrometer and Interferometer.	C. E. Herrick, Jr. I. Kirshenbaum	Aug 1942
A-725	Equilibrium Constant for the Reaction $HD + H_2O \rightleftharpoons HDO + H_2$.	F. B. Brown I. Kirshenbaum C. E. Herrick, Jr.	Aug 1942
A-727	Measurement of Density Differences with the Temperature Controlled Float.	R. J. Voskuyl Herbert Davis L. P. Saxer	5 June 1943
A-733	M.I.T. Monthly Report for June on WX Process.	Geo. Scatchard	14 June 1943
A-736	Summary Report of Complete Isotopic Analysis of Pure Product	H. H. Crist	18 June 1943
A-741	Production of HDO Water by Hydrogen Sulfide Method.	M. G. Amick	5 Dec 1942
A-745	WX Process	C. A. Hutchison A. M. Lyon	1 July 1943
A-754	Exchange of Deuterium Between Mercaptans and Water.	C. A. Hutchison Daniel Gillies	9 July 1943
A-756	The Density of Heavy Water.	I. Kirshenbaum	14 July 1943
A-758	Physical Properties of Heavy Water.	I. Kirshenbaum	23 Aug 1943
A-759	Final Report on the WX Process.	Geo. Scatchard	27 July 1943
A-760	Final Report on Catalysts for the Production of Heavy Water by the Hydrogen-Water Exchange for the Period 1 September 1942 to 31 July 1943.	H. R. Arnold J. E. Ahlberg A. de Bethune H. C. Hencken H. Kwart E. H. Taylor	31 July 1943
A-765	The Equilibrium Constant for the Exchange: $NH_3 + HD \rightleftharpoons NH_2D + H_2$.	C. E. Herrick, Jr. N. Sabi	30 July 1943

Cl.7

~~SECRET~~

~~SECRET~~

Report Number	Subject	By	Date
A-778	Mechanical Tests and Mechanical Properties.	C. Beck C. J. Craven	16 Aug 1943
A-797	Final Report Under Contract OEMsr-149. Mass Spectrometer Development.	A.O. C. Nier	20 Oct 1943
A-1201	Calculation of Hydrogen Isotopic Composition in Water.	R. J. Voskuyl	2 Sept 1943
A-1205	The WX Process.	Geo. Scatchard C. A. Hutchison	3 Sept 1943
A-1208	Analysis of Water in the Normal Range.	M. G. Inghram H.A. Chase	6 Oct 1943
A-1214	Supplemental Final Report on Product No. 80 for Project 9.	J. E. Ahlberg T. S. Blair A. J. de Bethune	5 Nov 1943
A-1222	Analysis of Water Samples by Equilibration.	R. H. Crist	23 Feb 1943
A-1233	Equilibration Method.	R. H. Crist I. Kirshenbaum	9 Jan 1944
A-1238	Report on Survey of Operations in Connection with the Production of Heavy Water by the Consolidated Mining and Smelting Co., Trail, B. C.	G. G. Joris	25 Jan 1944
A-1916	Final Report Under Contract No. W-7412 eng-68 for Manufacture of P-9 by the WX Process; Laboratory and Semi-Works Tests of Triethylamine in solvent Extraction.	W. P. Bebbington	15 Dec 1943
A-1933	Final Report on Contracts OEMsr-106, OEMsr-107, OEMsr-192, OEMsr-412, and Associated Sub-Contracts.	H. C. Urey	28 Feb 1944
M-18	Test on I.C.I. Catalyst	A. J. de Bethune	5 May 1943
M-19	Letter to C. H. Wright. re: Abundance of Deuterium in Lake Michigan and Trail Water & CM&S Coke Ammonia Hydrogen.	R. H. Crist	25 May 1943

C1.8

~~SECRET~~

~~SECRET~~

Report Number	Subject	By	Date
M-31	Determination of Deuterium Oxide in Water by the Falling Drop Method.	M. M. Wright	15 June 1943
M-33	The Hydrogen Isotopes Thermodynamic Properties of their compounds.	T. G. Fox	Sept 1942
M-49	Complete Isotopic Analysis of Special Water Samples.	R. J. Voskuyl	15 June 1943
M-68	Bibliography - Information Service - Report Library.	S. M. Feldman	28 July 1943
M-92	Letter to F. H. Pine (Harshaw) Re: Conference in Cleveland; Calcination & Reduction of Dry, Uncalcined Powder.	H. R. Arnold	23 July 1943
M-109	Analysis #4 on Check System - Mass Spectrometer Standards.	R. J. Voskuyl	20 July 1943
M-111	Report #5 on Check System - Mass Spectrometer Methods.	R. J. Voskuyl	27 July 1943
M-112	Report #6 on Check System - Mass Spectrometer Standards.	R. J. Voskuyl	2 Aug 1943
M-114	Report #8 on Check System.	R. J. Voskuyl	16 Aug 1943
M-122	Technical Progress Report, Period 1 - 15 August, 1943: P-9 Production and Analysis.	H. C. Urey R. H. Crist	18 Aug 1943
M-130	Report #9 on Check System - Mass Spectrometer Standards for Period 14 August to 21 August 1943.	R. J. Voskuyl	24 Aug 1943
M-131	Analysis of Pure Product by the Float.	R. J. Voskuyl	12 Aug 1943
M-136	Report #10 on Check System - Mass Spectrometer Standards. Period 21 August to 31 August 1943.	H. A. Chase	1 Sept 1943
M-145	P-9 Production and Analysis, Bi-Weekly Report for the Period 15 - 31 August 1943.	H. C. Urey R. H. Crist	4 Sept 1943
M-160	P-9 Production and Analysis, Report for the Period 1-15 September 1943.	H. C. Urey R. H. Crist	20 Sept 1943

Cl.9

~~SECRET~~

~~SECRET~~

Report Number	Subject	By	Date
M-165	Memo on Conference at Wilmington; Relative to Possible Research on the Production of Heavy Water.	H. C. Urey	9 Sept 1943
M-179	F-9 Production and Analysis, Bi-Weekly Report for the Period 16 - 30 September 1943.	H. C. Urey R. H. Crist	5 Oct 1943
M-527	Informal Report, Analytical Laboratory at Trail.	R. J. Voskuyl	9 Sept 1943
M-528	Memorandum to H. C. Urey, Analysis of Special Water Sample.	R. J. Voskuyl	2 July 1943
M-531	Narrative Report on four Projects -- K-25, Vitamin B, P-C and P-9.	-----	2 Dec 1943
M-533	Standard Oil Development - Summarizing Report to OSRD Covering Work on Project No. 9, including attachments A. B. C.	-----	12 Aug 1943
M-829	Narrative Report, Research and Development.	-----	1 Mar 1944
M-1159	Analysis of Water for Deuterium	I. Kirshenbaum	7 Sept 1944
S-68	Memorandum to Dr. L. J. Briggs on Recommendations Concerning the Production of Heavy Water by Electrolysis at Trail, B. C., Plant of the Consolidated Mining and Smelting Co. of Canada, Ltd.	T. H. Chilton H. S. Taylor H. C. Urey	- - -
S-78	The Separation of Deuterium by the Distillation of Liquid Hydrogen - Supplementary Memorandum.		21 Sept 1942
S-85	Determination of the Isotopic Composition of Water with the Zeiss Lab. Interferometer.	G. H. Walden, Jr.	29 June 1942
S-87	Fourth Progress Report Centrifugal Separation. Progress for month of September 1942.	Z. G. Deutsch E. W. Thiele R. Rosen	14 Oct 1942
S-90	Engineering Division - Monthly Report on Fractionation of Liquid Hydrogen.	J. K. Huffman	11 Nov 1942

Cl.10

~~SECRET~~

~~SECRET~~

Report Number	Subject	By	Date
S-92	Fifth Progress Report Centrifugal Separation. Progress for Month of October 1942.	E. V. Murphree	9 Nov 1942
S-97	Final Report on the Concentration of Deuterium Oxide by Catalytic Exchange at High Pressures.	A. K. Redcay	24 Nov 1942
S-100	Pressure Drops Through Catalyst SO-11-BC.	C. F. Hiskey G. F. Quinn	6 Dec 1942
S-101	Sixth Progress Report - Centrifugal Separation. Progress for Month of November 1942.	-----	14 Dec 1942
S-108	Final Report on the Concentration of Deuterium Oxide by Vapor Phase Catalytic Exchange at Low Pressures.	A. K. Redcay	16 Dec 1942
S-117	Eighth Progress Report on the Centrifuge Project, the Heavy Water Project and Miscellaneous Chemical Projects Dealing Mainly with Fluorocarbons and Fluorine.	W. J. Thompson E. W. Thiele R. Rosen	11 Feb 1943
S-124	Progress Report for Month of February Centrifuge Plant.	E. V. Murphree	10 Mar 1943

Cl.11

~~SECRET~~

~~SECRET~~

APPENDIX C2

CONTRACTS

(Filed in MED Classified Contract Files)

<u>Contract Number</u>	<u>Contractor</u>	<u>Subject</u>	<u>Date</u>	<u>(Effective From)</u>
OEMsr 107	Columbia University	Investigations of catalysts and other aids for separation of deuterium.	29 Oct 1941	1 July 1941
OEMsr 149	Univ. of Minnesota	Investigations of mass spectrographs and the construction of spectrometers.	19 Nov 1941	1 July 1941
OEMsr 166	Standard Oil Development Company.	Investigation, construction and operation of pilot plant for production of heavy water.	8 Dec 1941	1 Aug 1941
OEMsr 407	Standard Oil Development Company	Investigations of catalysts for large scale use for promoting exchange of deuterium.	23 May 1942	21 Jan 1942
OEMsr 412	Columbia Univ.	General investigations including that of separating heavy water.	23 May 1942	1 Dec 1941
OEMsr 482	Northwestern Univ.	Investigations of development and construction of continuous analytical apparatus.	18 June 1942	1 May 1942
OEMsr 693	Universal Oil Products Company	Investigations of nickel, or other catalysts for promoting exchange reaction.	15 Oct 1942	10 Sept 1942
OEMsr 776	E.I.duPont de Nemours & Co.	Engineering studies for production of a certain chemical by distillation.	8 Dec 1942	1 Oct 1942

C2.1

~~SECRET~~

~~SECRET~~

<u>Contract Number</u>	<u>Contractor</u>	<u>Subject</u>	<u>Date</u>	<u>(Effective From)</u>
OEMsr 797	Consolidated Mining & Smelting Co. of Canada, Ltd.	Preliminary engineering on a large scale P-9 plant. Alterations at contractor's plant to allow up to 5 stage cascade operation. Investigations and tests of catalysts.	4 Jan 1943	1 Feb 1942
W 7401 eng 13	Stone & Webster Engineering Corp.	General A-E-M services including those applicable to CM&S Co. plant at Trail, B. C.	29 June 1942	As dated
W 7405 eng 10	Consolidated Mining & Smelting Co., of Canada, Ltd.	Alteration of existing facilities and construction of new facilities, at contractor's Trail, B. C., plant, for production of P-9.	31 July 1942	As dated
W 7405 eng 11	Consolidated Mining & Smelting Co. of Canada, Ltd.	Operation of P-9 (Government) plant at Trail, B. C.	31 July 1942	As dated
W 7405 eng 16	Harshaw Chemical Company	Processing and delivering 90,000 pounds of Product No. 80.	3 Nov 1942	As dated
W 7405 eng 50	Columbia Univ.	Continuation of work terminated under preceding contract OEMsr 412.	7 June 1943	1 May 1943
W 7407 eng 6	Baker & Company, Inc.	Supply of the second charge, approximately 36,000 pounds, of product No. 43.	29 Mar 1943	As dated
W 7412 eng 4 (Letter Contract)	E.I. duPont de Nemours & Co.	Investigation of data, from engineering and operating viewpoint, for plant practicable for manufacture of P-9.	16 Nov 1942	As dated

C2.2

~~SECRET~~

~~SECRET~~

<u>Contract Number</u>	<u>Contractor</u>	<u>Subject</u>	<u>Date</u>	<u>(Effective From)</u>
W 7412 eng 4 (Continued)		Preparation of design for the preceding plant. Consultant services regarding development and adaptation of the subject design. Development, construction, and operation of the P-9 plant unit.		
W-ORD-490, Supplemental Agreement No. 7	E.I.duPont de Nemours & Co.	Supersedes Letter Contract W 7412 eng 4 for design, engineering, construction and operation of facilities for the production of Product No. 9 near Morgantown, W. Va.	11 May 1943	16 Nov 1942
W-ORD-526, DA-W-ORD-1 Supplemental Agreement Number 13	E.I.duPont de Nemours & Co.	Supersedes Letter Contract W 7412 eng 4 for design, engineering, construction and operation of facilities for the production of Product No. 9 at Childersburg (Sylacauga), Alabama.	11 May 1943	16 Nov 1942
W-ORD-556, DA-W-ORD-38 Supplemental Agreement No. 6.	E.I.duPont de Nemours & Co.	Supersedes Letter Contract W 7412 eng 4 for design, engineering, construction and operation of facilities for production of Product No. 9 at Newport (Montezuma), Indiana.	11 May 1943	16 Nov 1942

~~SECRET~~

~~SECRET~~

<u>Contract Number</u>	<u>Contractor</u>	<u>Subject</u>	<u>Date</u>	<u>(Effective From)</u>
W 7412 eng 68	E.I. duPont de Nemours & Co.	Studies of data relating to extraction of P-9, making use of triethylamine and provide confirmation by construction and operation of a small semi-works unit. Furnish consultant service to individuals to be designated.	15 Mar 1944	19 July 1944
W 7418 eng 70	Allied War Supplies Corp.	Agreement to the Boiler Plant Extension erection at Trail, B.C.	9 Dec 1943	12 Jan 1943

C2.4

~~SECRET~~

~~SECRET~~

APPENDIX D

LIST OF OTHER DATA IN FILES

- D1. Minutes of meetings of Policy Making Committees. MED Classified Files.
- D2. General correspondence, Manhattan District Classified Files.
- D3. Table, "Production of Ammonia in the United States and Canada . . . November 27, 1941", transmitted by letter 11 December 1941. MD 400.17 (9).
- D4. Letter, du Pont Co. to District Engineer, 7 April 1943, MD 600.12 (P-9).
- D5. Letter, Dr. H. C. Vernon, Columbia University, to General Groves, 9 April 1943. MD 600.12
- D6. Memorandum, District Engineer to General Groves, 27 April 1943. MD 400.1149
- D7. Letter, Stone & Webster to MED Area Engineer, Boston, Mass., 18 June 1943. MD 600.914 (Completion Report)
- D8. Letter, du Pont Co. to District Engineer, 24 December 1942. MD 600.1 (x463) (9)
- D9. Letter, du Pont Co. to District Engineer, 29 December 1942. MD 600.1 (x463) (9)
- D10. Memorandum, Major Traynor to District Engineer, 23 November 1943. MD 337 (P-9)
- D11. Letter, District Engineer to Dr. C. H. Wright, C. M. & S. Co., 27 March 1944. MD 400.1141 (9)
- D12. Letter, District Engineer to Dr. J. A. Monier, du Pont Co., 6 September 1944. MD 400.1141 (9)
- D13. Completion Report, Construction of Project No. 9, Trail Area, Trail, B. C., 1 September 1942 to 30 June 1943. MD 600.914 (Trail Completion)
- D14. Maps showing outlines of property leased by U. S. Government, at Trail, B.C. With Contract W-7406 eng-10 (see App. C2).

~~SECRET~~

~~SECRET~~

APPENDIX D (Continued)

- D15. Organising and Operating Instructions, Secondary Concentration Plant (Trail) - Operating Manual, Project 9, Section 900, Report 14. MD 461. (Dated 25 August 1943, with subsequent revisions)
- D16. Completion Report of Manhattan District Project constructed at Morgantown Ordnance Works. MD 600.914 MOW Completion
- D17. Completion Report, Job P-9, Wabash River Ordnance Works. MD 600.914. WOW Completion
- D18. Completion Report of P-9 Plant, Alabama Ordnance Works. 18 November 1943. MD 600.914 AOW Completion
- D19. Letter, du Pont Co. to MED, 31 March 1943, MD 400.112
- D20. Operating Manual for Plants in U. S. To supersede: "Memorandum Report TD-1, Preliminary Operating Manual, P-9 Manufacture, W-Process", dated 17 May 1943. MD 461.
- D21. Construction Drawings, Trail Plant. MED Record Retirement Section.
- D22. Construction drawings, Plant at Morgantown Ordnance Works. MED Record Retirement Section.
- D23. Construction drawings, Plant at Wabash River Ordnance Works. MED Record Retirement Section.
- D24. Construction drawings, Plant at Alabama Ordnance Works, MED Record Retirement Section.
- D25. Letter, du Pont Co. to District Engineer, 23 February 1943. MD 121.4 (9)
- D26. Letter, District Engineer to du Pont Co., 8 May 1943. MD 121.4 (9)
- D27. Letter, du Pont Co. to MED Area Engineer, Wilmington, Del., 27 July 1943, transmitted to District Engineer, 29 July 1943. MD 121.4
- D28. Monthly reports of operations from Area Engineer at Trail, B. C. MD 600.91 (9)
- D29. Letter, Dr. Urey to Major Traynor, 2 February 1944. MD 600.18 (9)
- D30. Memorandum, Major Sally to Major Traynor, 4 March 1944, MD 600.18 (9)

~~SECRET~~

~~SECRET~~

APPENDIX D (Continued)

- D31. Memorandum, Capt. Barnett to Major Traynor, 4 March 1944.
MD 400.17 (9)
- D32. Memorandum, Capt. Barnett to Major Traynor, 17 June 1944.
MD 337 (9)
- D33. Memorandum, Capt. Barnett to Major Traynor, 18 August 1944.
MD 400.17 (9)
- D34. Production records of Trail Plant. MED Production Files.
- D35. Operating costs of Trail Plant, MED Fiscal Disbursing Voucher File.
- D36. Memorandum, Capt. Barnett to Major Traynor, 2 November 1944.
MD 310 (9)
- D37. Letter, Field Director of Ammunition Plants, OCO, to C.O.,
Morgantown Ordnance Works, 4 June 1943. MD 600.18
- D38. Monthly reports of operations from du Pont Co. MD 600.914 (9)
- D39. Memorandum, Capt. Barnett to District Engineer, 17 June 1944.
MD 400.17 (9)
- D40. Memorandum, Capt. Barnett to Major Traynor, 20 July 1944.
MD 337 (MOW) (X400.17 (9))
- D41. Letter, Dr. Urey to District Engineer, 17 July 1944. MD 600.17 (9)
- D42. Letter, Dr. W. K. Lewis' Committee to District Engineer, 13
August 1944. MD 400.17 (9)
- D43. Letter, du Pont Co. to District Engineer, 25 August 1944.
MD 600.18 (9)
- D44. Letters (2), du Pont Co. to District Engineer, 3 January 1945.
MD 600.914 (9)
- D45. Production records of plants in U. S. MED Production Files.
- D46. Operating costs of plants in U. S. MED Fiscal Disbursing Voucher
File.
- D47. Letters (3), du Pont Co. to District Engineer, 9 February 1943,
30 March 1943, and 30 March 1943. MD 121.4 (9)
- D48. Operating Fees, Plants in U.S. MED Cost Section File.

~~SECRET~~

INDEX

Abbreviations:

AOW: Alabama Ordnance Works
App: Appendix

MOW: Morgantown Ordnance Works
WROW: Wabash River Ordnance Works

- Aokart, E. G., 6.3
- Administration, 6.1
- Alabama Ordnance Works, 1.2, 2.10
3.15
buildings, 4.22
Construction, 4.21; Costs,
4.25, 4.26
Contracts, 3.16, 4.21, 5.12,
App. C
Decisions, 2.10
Design, 3.15
fixed fee, construction, 4.25
operation, 5.12; costs, 5.25;
history of, 5.14
process, description of, 3.18
production, capacity, 2.10,
5.12, 5.15;
costs, 5.25; fees, 5.12,
records, 5.23
progress of construction, 4.24
site, 3.15; plan, 4.21, App. A
utilities, 4.23
- Allied War Supplies Corp, Canada,
3.3
- Area Gate and Guard House, AOW,
4.23; WROW, 4.18
- Areas, ground, at Trail, 3.3
- Artisan Metal Products, Inc., 4.2
- Assay Laboratory, 4.4
- Authorization, 1.5

- Badger & Sons Co., E. B., 2.10,
3.4, 3.5
- Baker, & Co., J.T., 3.8, 4.1, 4.2
- Barnett, Capt. M. J., 6.1, 6.2
- Basic Theory, 2.1
- Bebbington, Dr. W.P., 6.3, 6.4
- Boiler House, Trail, 4.6; MOW,
4.12; WROW, 4.18
- Booster Building, 4.3
- Brinkman, Major, E. A., 6.2
- Bubble caps, 4.11, 4.17, 4.22,
5.19, 5.20

- Buchanan, J., 6.4
- Buildings, Trail, 4.3; AOW, 4.22;
MOW, 4.10; WROW, 4.16

- Canadian Government, 3.3, 5.3
- Catalysts, 3.7; contracts, 3.4, 3.8,
3.9, 3.10, 4.1; studies and
investigations, 2.2
- Catalyst Shed, 4.6
- Catlett, Capt. W. A., 6.2
- Change House, Office and Laboratories,
AOW, 4.22; MOW, 4.11; WROW, 4.17
- Chicago, Univ. of, 2.13, 5.32
- Childersburg, See Ala. Ordnance Works.
- Chimneys, 5.20, 5.21
- Christman, J. M., 6.3
- Coke and natural gas, 2.5
- Columbia River, 2.8
- Columbia University, 2.3, 2.8, 3.8,
3.9, 6.2
- Completion of construction, Trail, 4.7,
4.8; AOW, 4.24; MOW, 4.13, 4.14;
WROW, 4.19, 4.20
- Concentration of heavy water, 2.1,
2.13, 2.14, 3.5, 3.20
- Congress, authority granted by, 1.3
- Consolidated Mining & Smelting Co., 2.8
contracts, 2.9, 3.2, 3.3, 4.1, 5.1,
App. C
decision, 2.8
fixed fee, 4.9
personnel, 6.1, 6.2, 6.3, 6.4
plant, 2.5, 3.1
studies, 2.3
- Construction, 4.1
Trail, 4.1, costs, 4.9, progress,
4.7
AOW, 4.21; costs, 4.25, progress,
4.24
MOW, 4.10, costs, 4.15, progress,
4.13
WROW, 4.16; costs, 4.20, progress,
4.19

Construction costs, Recapitulation, 4.26
Construction Personnel, 6.3
Consultants during operation, 5.19, 6.4
Contents, 1
Contracts, App. C
 for research projects, 2.2
 plants in U.S., 2.12, 3.16, 4.10, 4.16, 4.21, 5.11
 Trail plant, 2.9, 3.3, 4.1, 5.1
Cooling Tower, MOW, 4.12, Trail, 4.4
Coosa River, 3.15
Corpus Christi, Tex., 2.11
Costs,
 plants in U.S., 3.21, 4.15, 4.20, 4.25
 recapitulation (construction) 4.26
 Trail, 3.11, 4.9, 5.9
Custer, Gordon, 6.4

Data in files, technical reports and contracts, App. C;
 other, App. D
Decisions, principal, 2.8
 required, 2.6
Design and Engineering, 3.1
 personnel, 6.3
 plants in U.S., 3.11;
 procedure, 3.17
 Trail, 3.1; procedure, 3.4
Deuterium Oxide, 1.1, 2.1
Development, Research and, 2.1
 personnel, 6.2
Diagrams, flow (process),
 App. A
"Direct Method", 2.4
Distillation process, water, 2.7, 3.18
Distillation Towers, AOW, 4.22;
 MOW, 4.11; WROW, 4.17
 correction at MOW, 5.19, 5.20, 5.21
 proposed at Trail, 5.8
Dole, Dr. M., 6.2

Drawings, App. A, D
du Pont Co. (E.I. du P. de Nemours & Co.),
 contracts, 2.12, 3.16, 3.18, 4.10, 4.16, 4.21, 5.11
 fixed fee, AOW, 4.25; MOW, 4.15; WROW, 4.21
 personnel, 6.3, 6.4
 studies, 2.3
Electrolytic Cells, Trail, 3.5, 4.4;
 proposed increase, 5.7
Electrolytic Finishing process, 3.20;
 building, 4.11
Electrolytic Method (hydrogen production), 2.5, 2.7, 3.2
Engineering, Design and, 3.1
 personnel, 6.3
 plants in U.S., 3.11
 Trail, 3.1

Farrow, Edward S., 6.4
Fence, Trail, 4.7
Files, data in, App. C, D
Finishing (Electrolytic) Bldg., 4.11
 process, 3.20
Fisher, H. E., 5.3
Fixed fee, AOW, 4.25; MOW, 4.15;
 Trail, 4.9; WROW, 4.21
Flow diagrams, App. A
Fritz, H. W., 6.3

Gary, Tom C., 6.3
General Investigations, 2.5
Germans, 1.1
Graphite, 1.1
Ground areas, at Trail, 3.3
Groves, Maj. Gen. L.R., 1.3, 2.12, 6.1

Harshaw Chemical Co., 3.9, 3.10, 3.11, 4.1
Hartridge, A. L., 6.3
Heavy hydrogen, basic theory, 2.1;
 ratio in natural hydrogen, 2.1
Heavy water, 1.1; basic theory, 2.1;
 concentration, 2.1, 2.13, 3.5; 3.20;
 ratio in natural water, 2.1
Heresite, 2.7
Hicks Engineering Co., S. D., 4.2

- History of operation, plants in
 - U. S., 5.14; Trail, 5.4
- Hopkins, H. S., 6.4
- Housing, AOW, 3.16; MOW, 3.12;
 - WROW, 3.14
- Hydrogen, basic theory, 2.1
- Hydrogen, gas process, 2.6, 2.8,
 - 3.5
- Hydrogen Sulphide process, 2.7
- Inhibitors, 2.7
- Investigations, 2.5
- Isotopes, 2.1
- Jones, T. A., 6.4
- King, Capt. Joseph H., 6.2
- Krewatch, W. V., 6.4
- Layouts, of plants, App. A
- Leases, at Trail, 3.2, 4.2;
 - (operation contract), 5.2
- Lewis, Dr. W. K., 6.4
- Marshall, Col. J. C., 6.1
- Massachusetts Institute of
 - Technology, 2.3, 2.8
- Military Policy Committee, 1.3,
 - 6.1
- Minnesota, University of, 2.3,
 - 6.2
- Monier, Dr. J. A., 6.3
- Monongahela River, 3.11
- Montezuma, see Wabash River
 - Ordnance Works
- Morgantown Ordnance Works, 1.2
 - 2.10
 - buildings, 4.10
 - construction, 4.10; costs,
 - 4.15, 4.26
 - contracts, 3.17, 4.10, 5.11,
 - App. C
 - decisions, 2.10
 - design, 3.11
 - fixed fee, construction, 4.15
 - operation, 5.11; costs, 5.25;
 - history of, 5.14
 - process, 3.18
 - production, capacity, 2.10, 5.11,
 - 5.15;
 - costs, 5.25; fees, 5.11, records,
 - 5.23
 - progress of construction, 4.13
 - site, 3.11; plan, 4.10, App. A
 - utilities, 4.13
 - Murphree, Dr. E. V., 6.2
 - New Orleans, La., 2.11
 - Newport, see Wabash River Ordnance
 - Works
 - Nichols, Col. K. D., 2.12, 6.1
 - Nickel-chromium catalyst, 3.4, 3.7,
 - 3.9
 - Nier, Dr. A. O., C., 6.2
 - Nomenclature, 2.8
 - Northwestern University, 2.3, 6.2
 - Operating Costs,
 - plants in U.S., 5.25; Trail, 5.9
 - recapitulation, 5.29
 - Operating personnel, 6.4
 - Operation, plants in U.S., 5.11;
 - procedure, 5.13
 - Trail, 5.1
 - Ordnance Plants, see Alabama,
 - Morgantown and Wabash River
 - Ordnance Works
 - Organization and Personnel, 6.1
 - OSRD, 1.3, 2.2, 2.5, 2.9, 2.10, 6.1
 - Oxygen Scrubber, Tower, 4.4
 - Personnel, Organisation and, 6.1
 - Photographs, App. B
 - Pilot Plants, 2.2
 - Platinum-Charcoal catalyst, 3.7, 3.8
 - Plutonium, 1.1
 - P-9, definition, 1.1
 - Power House, See Boiler House
 - Primary Evaporator Bldg., 4.3
 - Primary Plant, Trail, process, 3.5
 - Primary Tower Structure, 4.3
 - Princeton University, 3.8, 6.2
 - Problem for solution, 2.1

Procedure, for design and engineering, plants in U. S., 3.17; Trail, 3.4
for operation, plants in U. S., 5.13
Process, description, plants in U.S., 3.18; Trail, 3.5; diagrams, App. A
Processes considered, 2.6
Process Pump and Control Bldg., AOW, 4.22; MOW, 4.10; WROW, 4.16
Product, specifications, 2.13
"Product 43", 3.8
"Product No. 80", 3.10
Product Storage Bldg, AOW, 4.23; MOW, 4.12; WROW, 4.17
Production, plants in U.S., 5.15; Trail, 5.5
capacity, plants in U.S., 2.10, 2.11, 5.11, 5.15, Trail, 2.8, 5.5
costs, plants in U.S., 5.25; Trail, 5.9
estimates, plants in U.S., 5.15; Trail, 5.5
fees, 5.12
recapitulation, records, 5.29; costs, 5.30
records, plants in U.S., 5.23; Trail, 5.8
Progress of construction, AOW, 4.24; MOW, 4.13; WROW, 4.19; Trail, 4.7
Pump House, Trail, 4.4; WROW, 4.18
Purchase Orders, 4.2
Purpose, 1.1
Read, Granville M., 6.3
Recapitulation, construction costs, 4.26
production costs, 5.30
production records, 5.29
Reports, technical, 2.2, App. C
Research and Development, 2.1; personnel, 6.2
Research projects, specific, 2.2
Rosbach, Major L. E., 6.2
Sally, Major J. F., 6.2
Secondary plant, building, Trail, 4.4
process, Trail, 3.7; (finishing) MOW, 3.20
Semi-finished product, specifications, 2.14
Shipments of material, 5.31
Shutdown, 5.23
Sites, plants in U. S., 3.11; plans, 4.10, 4.16, 4.21, App. A
Trail, 3.1; plan, 4.2, App. A
S-1 Committee of OSRD, 1.3, 2.7, 3.5, 3.8, 3.9, 6.1
Specifications of the product, 2.13; Semi-finished, 2.14
Specific Research Projects, 2.2
Stainless Steel, 2.7
Standard Oil Development Co., 6.2
contract, 2.2; investigation, 2.2
Start of construction, AOW, 4.24; MOW, 4.13; WROW, 4.19; Trail, 4.7
Startup of Operation, plants in U.S., 5.14; Trail, 5.3
Steam Boiler Plant, Trail, 4.6; (See also Boiler House)
Stone & Webster Engineering Corp., 2.10, 3.3, 3.8, 3.10, 4.1, 6.3, 6.4
Styer, Gen. W. D., 6.1
Summary, 31
Sylacauga, See Alabama Ordnance Works
Tadanao, B. C., 3.2
Taylor, Dr. H. S., 5.2
Technical reports, 2.2, App. C.
Teidje, H. F., 6.3
Thayer, Dr. V. R., 6.3, 6.4
Theory, basic, 2.1
Thiele, Dr. Ernest, 6.2, 6.4
Towers, AOW, 4.22; MOW, 4.11; WROW, 4.17; Trail, 4.3; (Proposed) 5.8
Trail, B.C., plant at, 1.1, 2.5, 2.8, 2.9, 3.1
buildings, 4.3
construction, 4.1; costs, 4.9, 4.26
contracts, 2.9, 5.3, 4.1, 5.1, App. C

decision, 2.8
design, 3.1; costs, 3.11
fee, construction, 4.9
leases, 4.2; (operation
contract), 5.1
operation, 5.1; history of,
5.3
process, 5.5
production, capacity, 2.6,
5.4; costs, 5.9; records,
5.8
progress of construction, 4.7
site, 5.1; plan, 4.2, App. A
utilities, 4.6
Traynor, Major H. S., 6.1
Triethylamine process, 2.4, 2.8
Tunnel caps, 4.11, 4.17, 4.22
Tyler, W. T., 6.3
Unanimity in decisions, 2.6
United States, plants in, - see
Alabama, Morgantown and
Wabash River Ordnance Works;
see also separate subjects
Universal Oil Products Co., 3.4,
3.9, 3.10, 3.11, 6.2; (studies)
2.3
Uranium, 2.2
Urey, Dr. H. C., 6.2
Utilities, AOW, 4.23; MOW, 4.13;
WROW, 4.19; Trail, 4.6
Wabash River Ordnance Works, 1.2,
2.10
buildings, 4.16
construction, 4.16; costs,
4.20; Recapitulation, 4.26
contracts, 3.17, 4.16, 5.12,
App. C
decisions, 2.10
design, 3.13
fixed fee, 4.21
operation, 5.12; history of,
5.14
production, capacity, 2.10,
5.12, 5.15; costs, 5.25;
fees, 5.12; records, 5.23
progress of construction, 4.19
site, 3.11; plan, 4.16; App. A
utilities, 4.19
Wardenburg, F. A., 6.3
Warehouse or Shop, AOW, 4.23;
WROW, 4.18
Warfield, B. C., 3.2
Water distillation process, 2.7,
2.10, 3.18
Webb, Dr. G. H., 6.2
Wells and Pumps, WROW, 4.18
Wells, Capt. W. G., 6.2
"W" process, 2.7
Wright, Dr. C. H., 6.3, 6.4